

# EXDUL-581E

EDP-No: A-371772

# EXDUL-581S

EDP-No: 371760

8 A/D inputs 16-bit (single ended) or  
4 A/D inputs 16-bit (differential)  
8 optocoupler isolated digital inputs  
2 optocoupler isolated digital outputs  
5 counters 32 bit  
LCD display (EXDUL-581E only)

**wasco**<sup>®</sup>

user's guide

## Copyright© 2019 by Messcomp Datentechnik GmbH

This documentation is copyright by Messcomp Datentechnik GmbH. All rights are reserved.

Messcomp Datentechnik GmbH reserves the right to modify the products described in this manual at any time and without preannouncement. No parts of this manual are allowed to be reproduced, copied, translated or transmitted in any way without prior written consent of Messcomp Datentechnik GmbH.

## Registered Trademarks

Windows®, Visual Basic®, Visual C++®, Visual C#® are registered trademarks of Microsoft.

**wasco®** is registered trademark.

**EXDUL®** is registered trademark. LabVIEW® is registered trademark.

Other product and company names mentioned may be trademarks of their respective owners

## Disclaimer

The information in this manual is intended to be accurate and reliable. The company Messcomp Datentechnik GmbH does not assume any liability for any damages arising out of the use of the A/D converter module EXDUL-581 and this documentation, neither for direct nor indirect damages.

## Important Information:

This manual was made up for the modules EXDUL-581E and EXDUL-581S. EXDUL-581E additionally provides an LCD display, all other functions are identical. For the EXDUL-581S all commands and functions concerning the LCD display are not applicable.

## Table of Contents

<b>1. Introduction</b>	<b>5</b>
<b>2. Connection Terminals</b>	<b>6</b>
2.1 Terminal Assignments of CN1	6
<b>3. System Components</b>	<b>7</b>
3.1 Block Diagram EXDUL-581E	7
3.2 Block Diagram EXDUL-581S	8
3.3 A/D Inputs	9
3.4 Digital Optocoupler Inputs	9
3.5 Digital Optocoupler Outputs	9
3.6 Counter	9
3.7 LCD Display (only EXDUL-581E)	9
<b>4. Deployment</b>	<b>10</b>
4.1 Connecting to an Ethernet Port	10
4.2 Connecting the Operating Voltage	10
4.3 Integrated Webpage of EXDUL-581E / EXDUL-581S	11
4.4 Password Protection - Access Code	11
4.5 Default Setting of the Network Configuration	12
4.6 Composition and Structure of the IP Address	12
4.7 How to Change the Network Configuration	13
4.8 Configuration with Static IP Address (DHCP deactivated)	14
4.9 Configuration with Dynamic IP Address (DHCP enabled)	16
4.10 LCD Display during the Booting Process (EXDUL-581E only)	17
4.11 LCD Display during Operation (EXDUL-581E only)	18
<b>5. Accessing the EXDUL-581</b>	<b>19</b>
5.1 Accessing via the EXDUL Web Page	19
5.2 Accessing via TCP/IP Sockets	20
5.3 How to Identify Hostname, IP Address and MAC Address	21
<b>6. 8 A/D Inputs 16 Bit</b>	<b>22</b>
6.1 Single ended Operation	22
6.2 Differential Operation	23
6.3 Combination of Single Ended and Differential Measurement	25
6.4 Input Voltage Range	25
6.5 Modes of Measurement	27
6.6 Adjustment of the A/D Inputs	29

<b>7. 8 Optocoupler Inputs .....</b>	<b>30</b>
7.1 Pin assignment of the input optocouplers.....	30
7.2 Input Circuitry .....	31
7.3 Input Current.....	31
<b>8. 2 Optically Isolated Outputs .....</b>	<b>32</b>
8.1 Pin assignment of the output optocouplers .....	32
8.2 Optocoupler specifications .....	32
8.3 Output circuitry .....	32
<b>9. Information, LCD and User Register.....</b>	<b>33</b>
9.1 Register HW Identification and Serial Number .....	33
9.2 Memory areas UserA, UserB, UserLCD1m* und UserLCD2m* .....	34
9.3 Display Register UserLCD-line1*, UserLCD-line2* and LCD Contrast* .....	34
<b>10. Installing the Driver .....</b>	<b>35</b>
<b>11. Programming .....</b>	<b>36</b>
11.1 Introduction .....	36
11.2 Modes of Programming .....	36
11.3 Programming under Windows using the .NET EXDUL.dll Library .....	36
11.4 Programming with TCP-Libraries.....	49
11.5 Access to the Module via LabVIEW and EXDUL.dll .....	86
<b>12. FAQ - Trouble Shooting .....</b>	<b>87</b>
<b>13. Specifications .....</b>	<b>92</b>
<b>14. Circuitry Examples.....</b>	<b>94</b>
14.1 Wiring of the Optocoupler Inputs .....	94
14.2 Wiring of the Optocoupler Outputs .....	96
14.3 Wiring of the A/D Inputs single ended .....	97
14.4 Wiring of the A/D Inputs differential .....	98
<b>15. ASCII Table.....</b>	<b>99</b>
<b>16. Product Liability Act.....</b>	<b>102</b>
<b>17. CE Declaration of Conformity .....</b>	<b>104</b>

## 1. Introduction

























The modules EXDUL-581E and EXDUL-581S are network-compatible digital I/O modules with Ethernet interface. Each module provides either eight ground-referenced or four differential 16-bit A/D input channels. Several bipolar input voltage ranges (+/-0.63 V, +/-1.27 V, +/-2.55 V, +/-5.1 V, +/-10.2 V) can be adjusted. The conversion process including the associated configuration of the A/D components (selection of range and channel) is triggered by software commands. Additionally the module provides eight digital inputs and two digital outputs which are galvanically opto-isolated by high-quality optocouplers and fitted with additional protection diodes. Special high power output optocouplers cope with a switching current up to 150 mA.

If required, five of the optocoupler inputs can be programmed and used as 32-bit counter inputs. The EXDUL-581E comes with a programmable LCD display presenting I/O status information or programmable user-specific data.

An external power supply is required to supply the necessary operating voltage. The module provides a 24-pin screw terminal block for connecting the power supply and the inputs and outputs. The compact chassis enables the module to be used as a portable device with a notebook. For mechanical or control engineering it can also be easily wall mounted or attached to DIN mounting rail.

## 2. Connection Terminals

### 2.1 Terminal Assignments of CN1

AIN01+	2 	 1	AIN00+
AIN03+	4 	 3	AIN02+
AIN05+	6 	 5	AIN04+
AIN07+	8 	 7	AIN06+
AGND	10 	 9	AGND
DIN1 / Counter1	12 	 11	DIN0 / Counter0
DIN3 / Counter3	14 	 13	DIN2 / Counter2
DIN5	16 	 15	DIN4 / Counter4
DIN7	18 	 17	DIN6
DOUT+	20 	 19	DIN_COM
DOUT1-	22 	 21	DOUT0-
GND_EXT	24 	 23	Vcc_EXT

**Vcc\_EXT:**

Connector for external voltage source

**GND\_EXT:**

Ground connection

### 3. System Components

#### 3.1 Block Diagram EXDUL-581E

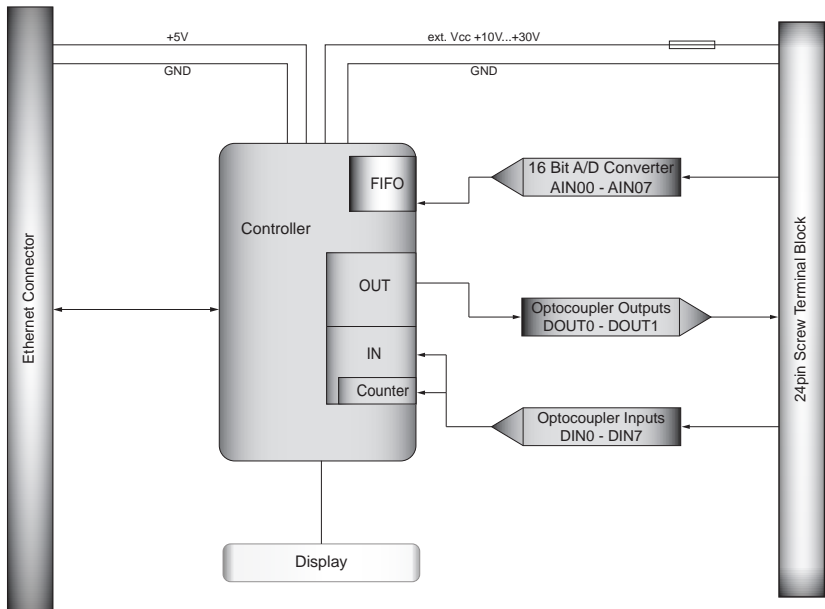

Fig. 3.1 Block diagram EXDUL-581E

### 3.2 Block Diagram EXDUL-581S

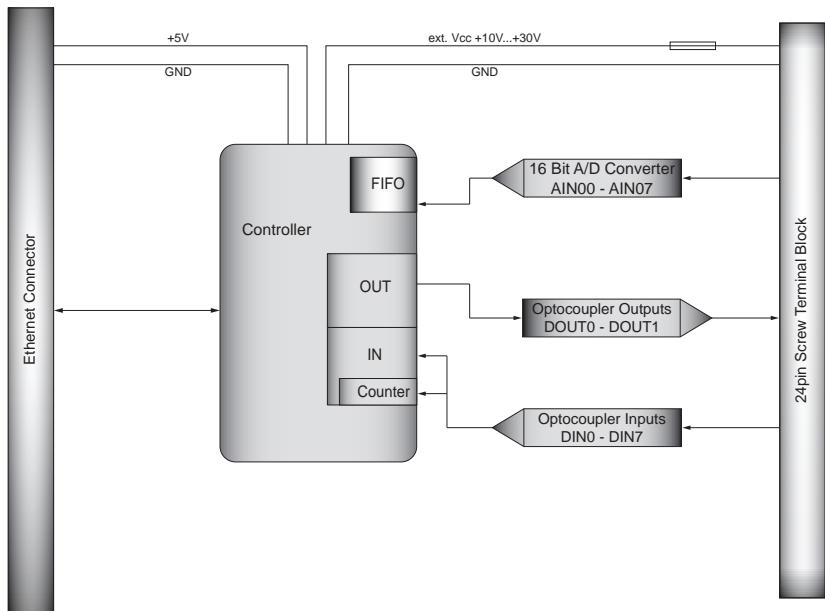

Fig. 3.2 Block diagram EXDUL-581S



### **3.3 A/D Inputs**

8 inputs single-ended (se)

or 4 inputs differential (diff)

or combined se/diff software-selectable

Resolution: 16 bit

Input voltage ranges bipolar:  $\pm 0.63$  V,  $\pm 1.27$  V,  $\pm 2.55$  V,  $\pm 5.1$  V,  $\pm 10.2$  V  
 $\pm 20.4$  V (differential inputs only)

FIFO: 10,000 measuring values

Input resistance:  $> 500$  M $\Omega$

Over voltage protection:  $\pm 50$  V

maximum sampling rate: 100kSps

### **3.4 Digital Optocoupler Inputs**

8 bipolar channels, galvanically isolated

Over voltage protection diodes

Input voltage range

high = 10..30 Volt

low = 0..3 Volt

### **3.5 Digital Optocoupler Outputs**

2 channels, galvanically isolated

High capacity optocoupler

Reverse polarity protection

Output current: max. 150 mA

Switching voltage: max. 50 V

### **3.6 Counter**

5 programmable counter 32 bit (occupying five optocoupler inputs)

Counting frequency: max. 5 kHz

### **3.7 LCD Display** (only EXDUL-581E)

Matrix display with 2 lines and 16 columns displaying 16 characters each line

Programmable to display user specific data or I/O state

## 4. Deployment

Connection to a network or to a computer is made in an easy and convenient way via an Ethernet interface, the configuration is made via any web browser. An external power supply unit is required for the necessary operating voltage.

### 4.1 Connecting to an Ethernet Port

The module EXDUL-581E / EXDUL-581S features a 10/100 Fast Ethernet interface with RJ45 connection and you can connect directly to a PC, Ethernet hub or Ethernet switch using a network cable.

After the operating voltage is applied the module will boot up. Once a stable connection is established, the green LED on the left side of the RJ45 jack is lit continuously.

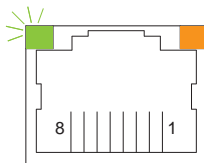

### 4.2 Connecting the Operating Voltage

The EXDUL-581E / EXDUL-581S requires a power supply of +10V ... +30V across terminal 23 (Vcc) and terminal 24 (GND).

### **4.3 Integrated Webpage of EXDUL-581E / EXDUL-581S**

Any web or internet browser such as Mozilla Firefox, Internet Explorer, Safari etc. can access to the web page of EXDUL-581 via a TCP/IP connection. The web page enables to read out connection information and to modify configuration data under password protection. The settings made are stored in the internal memory of the EXDUL-581 and are loaded during the booting process. The EXDUL-581 web page enables you to write, read-out and to display the user memory areas UserA, UserB, UserLCD1 and UserLCD2 as well as to start and to stop the counter or to monitor the digital inputs and outputs.

### **4.4 Password Protection - Access Code**

As mentioned before, using the EXDUL web page enables to configure the network, to set up the LCD display, to write into user specific memory areas as well as to set up the inputs and outputs or the counter. To prevent unauthorized access, these setting sections are password protected.

Following default access code is preset:

**User name:           admin**  
**Password:            11111111**

Please observe upper and lower case!

If you don't succeed in accessing with this access code, your system administrator changed the settings of the access code.

#### **4.5 Default Setting of the Network Configuration**

In the factory setting the EXDUL-581 is set to DHCP (Dynamic Host Configuration Protocol), i.e. to dynamic IP address. During initialization, the EXDUL-581 sends a request to the network (LAN). A network with active DHCP service will then automatically assign an IP address to the module. This setting allows an easy and convenient connection of the module and to adjust custom-fit configuration data.

#### **4.6 Composition and Structure of the IP Address**

IPv4 addresses consist of 32 Bits = 4 Bytes (octets). Each Byte can range from 0 to 255. It is shown as four decimal numbers separated by dots (e.g. 192.168.1.83).

Each IP address consists of a network and a host part (host identifier). A subnet mask divides network part and host part. All devices located in the same network can communicate with each other.

Example:

If subnet mask 255.255.0.0 is allocated to the IP address 192.168.1.83, then the device is located in the network 192.168.-.- as device -.1.83.

## 4.7 How to Change the Network Configuration

To change the factory default configuration settings, connect the EXDUL-581 to a local network using the enclosed standard network cable and connect the power supply (+10 V ...+30 V) across terminal 23 (Vcc) and terminal 24 (GND) of the module. The EXDUL boots up immediately. Once a stable Ethernet connection is established, the green LED on the left side of the RJ45 jack is lit green continuously. Access to the EXDUL-581 web page is possible using any web or internet browser by prompting the hostname **http://EXDUL-581**. Click the TCP/IP Config button to open the following configuration screen:

You can use the enclosed standard network cable to connect EXDUL-581 also directly to a host PC with an Ethernet interface. If you connect directly, normally no DHCP service is available, for neither the PC nor the EXDUL provides one. In this case, the last set static IP address can be used for addressing the EXDUL-581. The IP address 169.254.1.1 is applicable for factory-new EXDUL devices.

## Important Information:

The PC used and the connected EXDUL are to be located in the same network to be able to communicate. For this purpose, DHCP has to be deactivated on the computer and the first two number blocks (192.168) of EXDUL IP address 192.168.1.83 (Subnet mask 255.255.0.0) are to be transferred to the computer's IP address. The next two number blocks can be assigned with values between 0 and 255 adjusted to your current requirements.

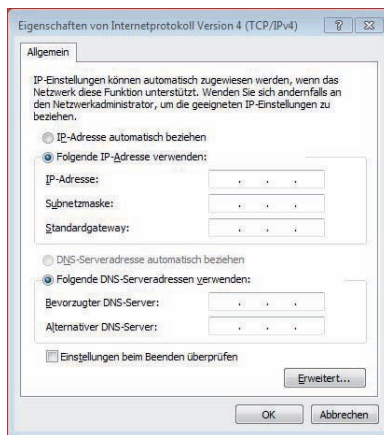

The network part of the IP address depends on the subnet mask. From the IP address of the Exdul-581 all octets that are assigned 255 in the subnet mask are to be transferred to the computer's IP address (see chapter 4.6 Composition and structure of IP address)

## 4.8 Configuration with Static IP Address (DHCP deactivated)

To configure EXDUL-581 to the static IP address, DHCP has to be deactivated in the EXDUL-581 configuration screen. To change the configuration, connect the EXDUL-581 to a LAN or PC as per description in chapter 4.7 (How to change the network configuration).

Once a stable Ethernet connection is established, you can access the EXDUL-581 web page via any Internet browser. Upon prompting the host-name **http://EXDUL-581**, the browser should open the EXDUL-581 web page. Click the button TCP/IP Config to open following configuration scr

Once you disabled DHCP, you can enter your desired IP address, subnet mask, and the desired hostname. By clicking the button **Konfiguration speichern**, the currently entered data will be transferred to the internal memory of the EXDUL-581. From this point on, the module only can be addressed via the IP address set here, or via the indicated hostname, respectively. The used PC or LAN must be located in the same network.

**Important note:** Each device or module in a network must have its unique IP address or hostname, second assignment is not permitted! The host-name may be chosen arbitrarily, but may contain only the ASCII digits 0 through 9 and the letters A through Z (leave out upper and lower case) and - (hyphen-minus).

Some IP addresses are reserved or have special functions such as: 127.0.0.1 (local host).

192.168.1.0 (0 is the network address) with 255.255.255.0 (subnet mask).

Please consult your network administrator which IP address you may use. If you use an invalid IP address the access to the module may then be impossible. The setting of the most important impermissible addresses is blocked by the module.

#### 4.9 Configuration with Dynamic IP Address (DHCP enabled)

If you want to implement the EXDUL-581 into an existing network with an already active DHCP server and to map it via a dynamic IP address, DHCP (Dynamic Host Configuration Protocol) has to be activated in the configuration screen of the web page. In factory default setting, DHCP is already activated and there is no need to change.

If the IP address is set statically, activate DHCP as follows:

Connect the EXDUL-581 to a computer using a network cable (older computers may need a crossover network cable). Please make sure that the computer is set to: **Folgende IP-Adresse verwenden: (DHCP deaktiviert)**

The network part of the IP address (see chapter 4.6 Composition and structure of IP address) has to be transferred from the IP address of the EXDUL-581, because the computer and the EXDUL are to be located in the same network.

Connect the power supply (+10 V ...+30V) across terminals 23 (Vcc) and 24 (GND) of the module. The EXDUL will boot up immediately. Once a stable connection is established, the LED on the left side of the RJ45 jack is lit green continuously.

Access to the EXDUL-581 web page is possible using any internet browser entering the hostname or IP address of the EXDUL-581. The browser now should open the EXDUL web page. Clicking the TCP/IP Config button opens the configuration screen and you can activate DHCP by setting the checkmark **Enable DHCP** as shown in the following figure:



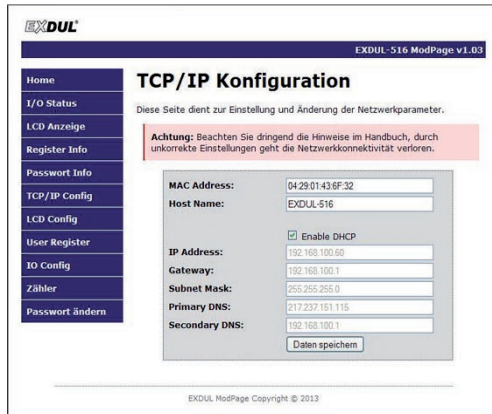

### Important note:

We strongly recommend to consult your network administrator before activating DHCP. If you want to embed several identical modules of the series EXDUL-5xx into one network, the presetted hostname of each module has to be changed. Each hostname within a network must be assigned to only one device or module. The hostname can be chosen arbitrarily, but may contain only the ASCII digits 0 through 9 and the letters A through Z (leave out upper and lower case) and - (hyphen-minus).

### 4.10 LCD Display during the Booting Process (EXDUL-581E only)

During booting-up the module, the display shows information data. Line 1 indicates the module name, line 2 displays the information that the module is being initialized. After having completed the boot process, in both cases the display shows either I/O status information or UserLCD information depending on your configuration.

#### **4.11 LCD Display during Operation (EXDUL-581E only)**

After having completed the boot process, the display switches from information display to I/O status display or UserLCD display depending on the setting. If the I/O status is displayed, line 1 indicates the current states of the inputs, line 2 the states of the outputs. If the UserLCD mode has been activated in the EXDUL-581 web page, the display shows UserLCD data with the values from the memory areas UserLCD1m and UserLCD2m instead of I/O status display.

You can see the values of UserLCD1m and UserLCD2m on the LCD display unless you write new user data in UserLCD line1 and line2 of the LCD display. In order to avoid „screen-burn“ during operation, the display alternates from I/O status display or UserLCD display to information display with the current IP address for approx. 5 seconds every minute.

## 5. Accessing the EXDUL-581

As mentioned before, access to the configuration set-up and to the inputs and outputs of the EXDUL-581 is possible via the EXDUL-581 web page or via TCP/IP sockets. For this you need to know IP address, hostname or MAC address.

### 5.1 Accessing via the EXDUL Web Page

The web page of the EXDUL-581 allows to read inputs, set outputs, read out memory areas UserA, UserB and UserLCD as well as to read out connection or module information or to change configuration data. You can access to the web page via any internet browser from any computer connected to the module. The computer used has to be set to „**IP-Adresse automatisch beziehen (DHCP-aktiviert)**“ as long as the module still is in its delivery state (DHCP enabled) and if it is integrated in a network with active DHCP service. Entering the hostname (in default state **http://EXDUL-581**, otherwise the name you chosed, or you might determine it via ExdulUtility\_v2\_xx or later) you can open the web page. If you don't succeed in opening the EXDUL-581 web page, please check the network connections or the entered hostname. For more details see chapter FAQ - Troubleshooting.

**EXDUL** EXDUL-516 ModPage v1.03

**EXDUL-516**

Die EXDUL-516E und EXDUL-516S sind netzwerkfähige, digitale I/O-Module mit Ethernet-Interface.

Jedes Modul verfügt über 10 digitale Eingänge und acht digitale Ausgänge mit galvanischer Trennung über hochwertige Optokoppler und zusätzlichen Schutzdioden. Alle Eingangsoptokoppler verfügen über eine integrierte Schmitt-Trigger-Funktion, die speziellen leistungsfähigen Ausgangsoptokoppler bewältigen einen Schaltstrom von bis zu 150 mA. Ein Optokoppler-Eingang kann bei Bedarf auch als Zähler-Eingang programmiert und genutzt werden.

Das EXDUL-516E bietet zusätzlich eine LCD-Anzeige zur Darstellung von I/O-Statusinformationen oder anwenderspezifischen Daten. Die Anschlüsse für die notwendige externe Spannungsversorgung sind wie die Anschlüsse der Eingangs- und Ausgangsoptokoppler der 24poligen Schraubklemmleiste zugeführt.

EXDUL ModPage Copyright © 2013

## 5.2 Accessing via TCP/IP Sockets

Using the TCP protocol, a reliable connection between the computer and the EXDUL-581 will be achieved. The protocol automatically takes actions in case of data loss. The module is mapped via a 4 Byte IP address (IPv4) or via the assigned hostname respectively and a port number 9760. The computer transmits one byte array for every command via this connection. The module processes the command and always sends a response. In combination with a high-level language, the TCP/IP connection allows to read the inputs, set the outputs, start, stop and to read out the counter, to write user specific memory areas, to read out the connection or module information and to change configuration settings as well.

### 5.3 How to Identify Hostname, IP Address and MAC Address

If you don't know neither the hostname nor the IP address or the MAC address of the EXDUL-5xx modules, the search tool ExdulUtility\_v2\_xx (or later) enables you to detect these addresses. If your firewall prevents the search program from communicating with the EXDUL-5xx, the program needs to be allowed.

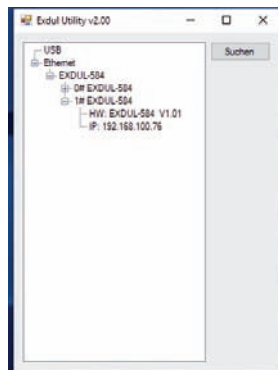

The **ExdulUtility\_v2\_xx** search program (or a later version) is provided on the EXDUL software CD or available for download at [www.messcomp.com](http://www.messcomp.com)

## 6. 8 A/D Inputs 16 Bit

The EXDUL-581 provides 8 multiplexed single ended or 4 differential 16-bit A/D input channels with programmable input voltage range. When the conversion is triggered, the computer will transfer configuration data for conversion (channel, range) in the form of two bytes. After error corrections (such as offset error) the module transmits the measured value transformed in a voltage value in  $\mu\text{V}$  as a response or stores it into a FIFO.

### 6.1 Single ended Operation

In single ended operation mode, a maximum of 8 input channels are available. All input voltage ranges are measured against the ground (ADGND) of the A/D components (see figure 6.1). Find a more detailed description of the circuitry in chapter 13.3

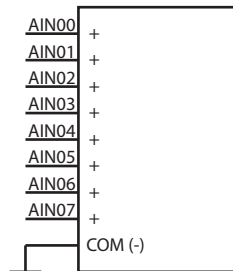

Figure 6.1 A/D converter single ended

As mentioned before, one byte for channel selection will be added to the command for measuring the voltage.

Please see table 6.1 to choose the appropriate value for each channel when single ended measuring is used.

Channel Byte	Channel selection single ended								
	1	2	3	4	5	6	7	8	ADGND
0 <sub>dez</sub>	+								-
1 <sub>dez</sub>		+							-
2 <sub>dez</sub>			+						-
3 <sub>dez</sub>				+					-
4 <sub>dez</sub>					+				-
5 <sub>dez</sub>						+			-
6 <sub>dez</sub>							+		-
7 <sub>dez</sub>								+	-

Table 6.1 A/D converter single ended measurement

For example, for a single ended measurement of channel 3, the positive pole of the voltage source has to be connected to AIN02 and the negative pole to ADGND. The channel byte of the command then is 2<sub>dez</sub>.

## 6.2 Differential Operation

In differential operation, a maximum of 4 input channels are available. In differential mode each channel provides one positive and one negative input (see figure 6.2-1). Please note, all channels must be referenced to the ground (ADGND) as well. Find a more detailed description of circuitry in chapter 13.4.

The differential measurement can reduce generally occurring interference voltages on both of the signal lines and the analog ground.

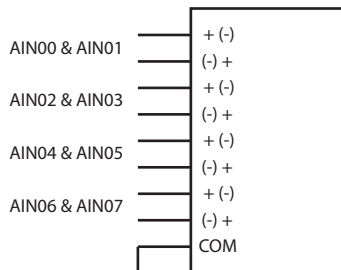

Figure 6.2-1 A/D converter differential measurement

Here too, the channel is selected via the channel byte added to the command for measuring the voltage. You can find the corresponding values in following table:

Channel Byte	Differential channel selection								
	1	2	3	4	5	6	7	8	ADGND
8 <sub>dez</sub>	+	-							
9 <sub>dez</sub>	-	+							
10 <sub>dez</sub>			+	-					
11 <sub>dez</sub>			-	+					
12 <sub>dez</sub>					+	-			
13 <sub>dez</sub>					-	+			
14 <sub>dez</sub>							+	-	
15 <sub>dez</sub>							-	+	

Table 6.2 A/D converter differential measurement

Serving as an example now the difference between two voltages shall be measured at the inputs AIN05 and AIN06. For this purpose, connect the first voltage to AIN05 and the second one to AIN06 (see figure 6.2-2).

Now either the value 12<sub>dez</sub> (AIN05+ / AIN06-) or 13<sub>dez</sub> (AIN05- / AIN06+, the result is a negative differential voltage!) can be used as channel byte.

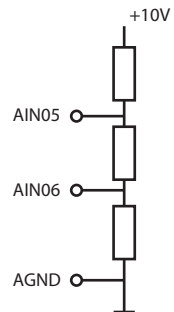

Fig. 6.2-2

### Attention:

Please take particular care to ensure, that the difference between the inputs is within the input voltage range. An input voltage of +10V at AIN05 and an input voltage of -10V at AIN06 results in a difference of +20V, i.e. an input voltage range of +/- 20.4V must be chosen (see chapter 6.4)



### 6.3 Combination of Single Ended and Differential Measurement

If required, the measurement methods can also be varied channel by channel as in fig. 6.3 or even changed „on the fly“ between the individual measurements.

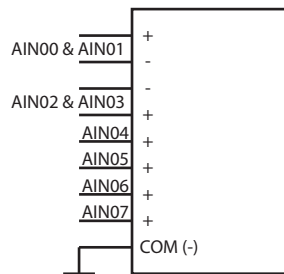

Fig. 6.3

### 6.4 Input Voltage Range

To measure a voltage, several input voltage ranges are available (+/-0.63 V, +/-1.27 V, +/-2.55 V, +/-5.1 V, +/-10.2 V). This permits the range to be adjusted to the input signal, thus optimizing the measuring accuracy. Along with the measuring command, the computer sends a range byte to the module to select the voltage range.

Following the individual ranges and the corresponding byte values are listed:

Input Voltage Range	
Byte Value	Voltage
0	+/- 20.4V (differential measuring only max +/- 10.2V → GND)
1	+/-10.2V
2	+/- 5.1V
3	+/-2,55V
4	+/-1.27V
5	+/- 0.63V

Table 6.4 A/D converter input voltage ranges

a) Single-Ended Measurement

As shown in Fig. 6.4.1, when measuring single-ended, the input signal is referenced to the ground. The maximum or minimum voltage to be measured at a voltage range of +/- 10.2V is +10.2V and -10.2V respectively.

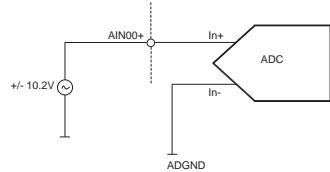

Fig. 6.4.1

**Attention:** since the maximum voltage to be measured at the analog input (e.g. AIN00+) is 10.2V, a voltage range of +/- 20.4V is not available for a single-ended measurement!

b) Differential measurement

For differential measurements, the input voltage range used corresponds to the maximum difference between the selected inputs. For this, as shown in Fig. 6.4.2, an input voltage range of +/- 0.63V can be chosen, although a voltage of up to +/- 10.2V is applied at the inputs.

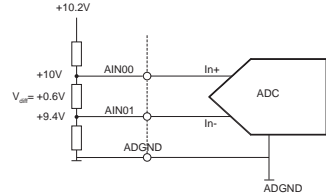

Fig. 6.4.2

When using differential measurement, in contrast to the single-ended measurement, there is also an input voltage range of +/- 20.4V.

**Attention:** For an input voltage range of +/-20.4V the maximum or minimum input voltage of +10.2V resp. -10.2V is true. Only the difference between two inputs may be +20.4V or -20.4V (e.g. AIN00 = +10.2V and AIN01 = -10.2V,  $V_{diff} = 20.4V$ )

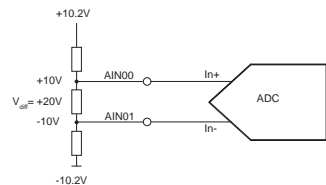

Fig. 6.4.3

## 6.5 Modes of Measurement

To facilitate the application, the EXDUL-581 provides several modes of measurement.

### 6.5.1 Single voltage measurement

In the single measurement, upon receiving the appropriate command, the module performs a measurement on the selected input, calibrates it and returns the value in  $\mu\text{V}$  to the user.

### 6.5.2 Single voltage measurement with averaging

In this measurement mode, the module performs 32 measurements at the user-selected input at scan intervals of  $10\ \mu\text{s}$  each, forms an average, calibrates the measurement and provides the result in  $\mu\text{V}$  to the user.

This measurement mode is particularly suitable for smaller input voltage ranges in order to suppress interferences such as noise.

### 6.5.3 Block measurement with averaging

This measurement mode is intended for applications, in which voltages at several inputs are to be measured as precisely as possible and in a timely manner. Along with transmitting the command to the module, the selected channels (up to 8) with the respective voltage range are transferred. Upon receiving the command, the module starts sampling each desired channel successively 32 times in  $10\ \mu\text{s}$  increments.

Duration = Number of channels\*32\*10 $\mu\text{s}$

After completion, the values are calibrated and returned to the user in  $\mu\text{V}$ .

Example:

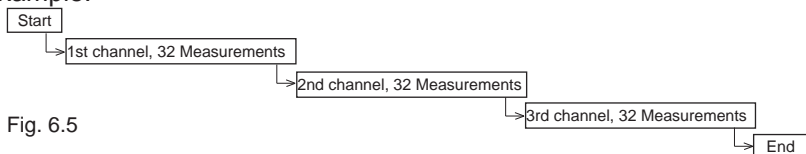

Fig. 6.5

In this example, three channels are to be sampled (e.g. AIN01+, AIN03+, AIN05+). These channels are transferred along with the command, and the module starts running 32 measurements of the first channel (here AIN01+). As soon as the measurements of the first channel have been completed, the sampling of the second channel is started. Once all of the channels have been sampled (duration here  $960\mu\text{s} = \text{number of channels} \cdot 32 \cdot 10\mu\text{s}$ ), offset and gain errors are calibrated and the voltages in  $\mu\text{V}$  are transferred.

#### 6.5.4 Multiple measurement

In the multiple measurement mode, up to 8 channels can be sampled several times (up to 65,535 times). Along with the command, the desired sampling rate (1 - 100kS/s) and the desired channels with the respective voltage range are transmitted. Upon receiving the command, the module performs the measurements and stores the calibrated values in  $\mu\text{V}$  into the FIFO. These values can be retrieved from the FIFO at any time. It is important to ensure that the FIFO does not overflow. It is recommended to operate this measurement mode with a sampling rate of up to 20kS/s only at a measurement count of more than 10,000 measurements. Additionally, you must not write to any EXDUL information register during this period.

#### 6.5.5 Continuous measurement

In the continuous measurement mode, up to 8 channels with any measuring range and up to 100kS/s can be sampled in continuous operation. For this purpose, there is a start and a stop command. The calibrated measured values in  $\mu\text{V}$  are written to the FIFO and can be retrieved from there at any time. It is important to ensure that the FIFO does not overflow. It is recommended to operate this measurement mode with a sampling rate of up to 20kS/s only. Additionally, you must not write to any EXDUL information register during this period.

## **6.6 Adjustment of the A/D Inputs**

The module is calibrated at an ambient temperature of approx. 20°C during the final test of our production. If there are larger temperature deviations in the end application, the A/D component can be adapted to the environment by subsequent adjustment. The required software is provided on the enclosed CD or on the Internet.

## 7. 8 Optocoupler Inputs

The EXDUL-581 provides 8 input channels, each of which is optically isolated by optocouplers. The isolation voltage between the ground of the computer and the input is 500 volts. The voltage within the input channels is limited to 50 volts.

### 7.1 Pin assignment of the input optocouplers

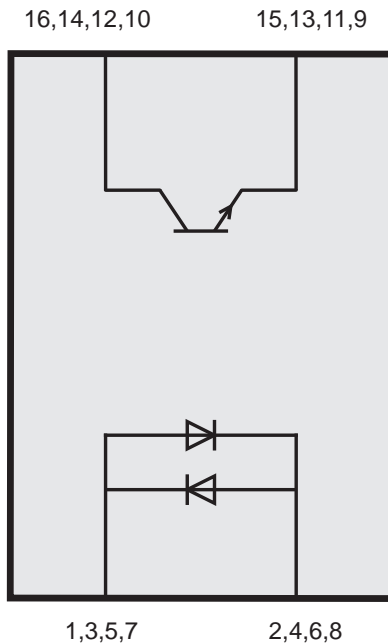

Fig. 7.1

## 7.2 Input Circuitry

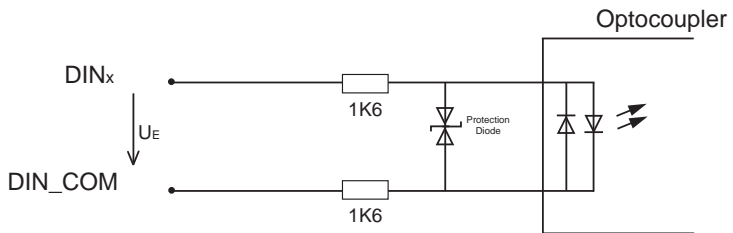

Fig. 7.2

## 7.3 Input Current

$$I_E \approx \frac{U_E - 1,1V}{3200\Omega}$$

## 8. 2 Optically Isolated Outputs

The EXDUL module provides 2 output channels, which are optically isolated by optocouplers. The isolation voltage between the ground of the computer and the output is 500 volts.

### 8.1 Pin assignment of the output optocouplers

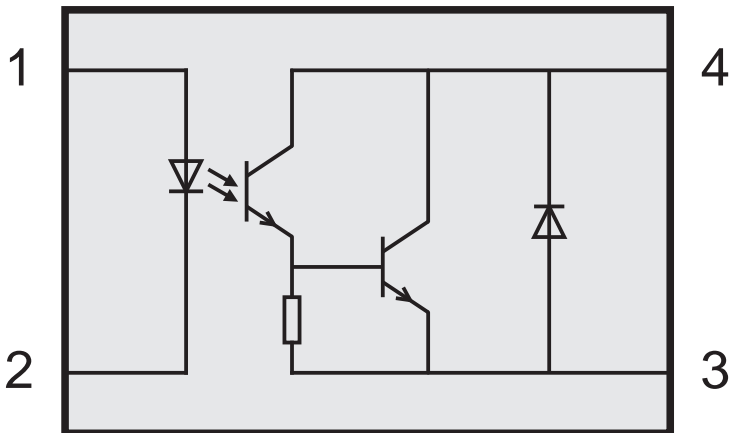

### 8.2 Optocoupler specifications

Voltage collector-emitter:	max. 50V
Voltage emitter-collector:	0,1V
Current collector-emitter:	150 mA

### 8.3 Output circuitry

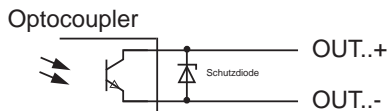



## 9. Information, LCD and User Register

### 9.1 Register HW Identification and Serial Number

Byte	0	1	2	3	4	5	6	7	8	9	10	11	12	13	14	15
HW Identification	E	X	D	U	L	-	5	8	1			V	1	.	0	1
	45 <sub>hex</sub>	58 <sub>hex</sub>	44 <sub>hex</sub>	55 <sub>hex</sub>	4C <sub>hex</sub>	2D <sub>hex</sub>	35 <sub>hex</sub>	38 <sub>hex</sub>	31 <sub>hex</sub>	20 <sub>hex</sub>	20 <sub>hex</sub>	56 <sub>hex</sub>	31 <sub>hex</sub>	3E <sub>hex</sub>	30 <sub>hex</sub>	31 <sub>hex</sub>
S/N	1	0	4	4	0	2	6									
	31 <sub>hex</sub>	30 <sub>hex</sub>	34 <sub>hex</sub>	34 <sub>hex</sub>	30 <sub>hex</sub>	32 <sub>hex</sub>	36 <sub>hex</sub>									

Table 9.1 Register HW identification and serial number

The module name as well as the firmware version are stored in the HW identification register and can be used to determine the product identity by the user. The table above serves as an example as for the module EXDUL-581 with firmware version 1.01. The line HW identification shows each Hex value and the corresponding ASCII character.

The register Serial Number is a read-only register. The serial number in the table above serves as a format example. The line S/N shows each Hex value and the corresponding ASCII character as for the serial number 1044026.

## 9.2 Memory areas UserA, UserB, UserLCD1m\* und UserLCD2m\*

Byte	0	1	2	3	4	5	6	7	8	9	10	11	12	13	14	15
UserA																
	20 <sub>hex</sub>	20 <sub>hex</sub>	20 <sub>hex</sub>	20 <sub>hex</sub>	20 <sub>hex</sub>	20 <sub>hex</sub>	20 <sub>hex</sub>	20 <sub>hex</sub>	20 <sub>hex</sub>	20 <sub>hex</sub>	20 <sub>hex</sub>	20 <sub>hex</sub>	20 <sub>hex</sub>	20 <sub>hex</sub>	20 <sub>hex</sub>	20 <sub>hex</sub>
UserB																
	20 <sub>hex</sub>	20 <sub>hex</sub>	20 <sub>hex</sub>	20 <sub>hex</sub>	20 <sub>hex</sub>	20 <sub>hex</sub>	20 <sub>hex</sub>	20 <sub>hex</sub>	20 <sub>hex</sub>	20 <sub>hex</sub>	20 <sub>hex</sub>	20 <sub>hex</sub>	20 <sub>hex</sub>	20 <sub>hex</sub>	20 <sub>hex</sub>	20 <sub>hex</sub>
UserLCD1m*																
	20 <sub>hex</sub>	20 <sub>hex</sub>	20 <sub>hex</sub>	20 <sub>hex</sub>	20 <sub>hex</sub>	20 <sub>hex</sub>	20 <sub>hex</sub>	20 <sub>hex</sub>	20 <sub>hex</sub>	20 <sub>hex</sub>	20 <sub>hex</sub>	20 <sub>hex</sub>	20 <sub>hex</sub>	20 <sub>hex</sub>	20 <sub>hex</sub>	20 <sub>hex</sub>
UserLCD2m*																
	20 <sub>hex</sub>	20 <sub>hex</sub>	20 <sub>hex</sub>	20 <sub>hex</sub>	20 <sub>hex</sub>	20 <sub>hex</sub>	20 <sub>hex</sub>	20 <sub>hex</sub>	20 <sub>hex</sub>	20 <sub>hex</sub>	20 <sub>hex</sub>	20 <sub>hex</sub>	20 <sub>hex</sub>	20 <sub>hex</sub>	20 <sub>hex</sub>	20 <sub>hex</sub>

Each of the registers UserA and UserB hold 16 digits (16 byte) for customizing. The data is retained when you switch off, registers can be set back to their factory settings (delivery state) by a default reset. In delivery state in all of the user memory areas each digit is set to the Hex value 20 corresponding to a blank in ASCII code.

The table above shows each Hex value and the corresponding ASCII character.

## 9.3 Display Register UserLCD-line1\*, UserLCD-line2\* and LCD Contrast\*

If UserLCD mode is activated you can write to both of the UserLCD-line1 and UserLCD-line2 registers any 16 characters. Once transmitted, this will be displayed instead of the data from UserLCD1m\* and UserLCD2m\*. The data in the registers UserLCD-line1 and UserLCD-line2 is **not** retained when switching off.

You can adjust the LCD display contrast in register LCD contrast. This adjustment is retained when switching off.

\*: EXDUL-581E only, no application for EXDUL-581S

## **10. Installing the Driver**

The Ethernet module EXDUL-581 does not require any driver. Precondition is a provided network connection from the computer (network interface card with driver) or from a mobile device. For direct access to the module, the TCP/IP libraries are required, which are available in many high-level languages such as C, C++, C#, Visual Basic or Java. Access examples in several programming languages are provided on the enclosed CD or on our website [www.mewsscomp.com](http://www.mewsscomp.com).

## 11. Programming

### 11.1 Introduction

You can program using the default TCP/IP protocol and thus via so-called TCP/IP sockets, for which many commonly used programming languages provide standard libraries. The use of .Net Frameworks of Microsoft permits a simple and fast implementation. Using the default protocol, additionally to the Windows system the module can be connected to many other operating systems such as Ubuntu (based on Linux) or Android. You can find various programming examples on the enclosed CD and on our website.

### 11.2 Modes of Programming

There are several ways to access to the EXDUL module. So the library EXDUL.dll can be used for programming under Windows and .NET. This allows a quick and easy start to program the access to the module. Furthermore, you can use TCP and Socket libraries which are available in many programming languages such as C# or Java. They often allow a wide range of interface settings. LabVIEW user also easily can access to the module using the EXDUL.dll or TCP function blocks.

### 11.3 Programming under Windows using the .NET EXDUL.dll Library

If you use a .NET programming language (C#, C++, .NET or VB.NET) to access to the module, you can use the EXDUL.dll Library. It is structured object-oriented, so each EXDUL module is represented by an object with its methods. Developing the library, special regard was paid to an API between the different EXDUL modules as uniform as possible. This facilitates the user, if necessary, to switch from e.g. an Ethernet EXDUL module to a USB EXDUL module (for example EXDUL-581 -> EXDUL-381) without extensive programming efforts.

## Overview of commands using EXDUL.dll Library

**Open:** Establishes the connection to the module  
[bool](#) Open()  
Returned values: true if successful / false at error

---

### Close

void Close()  
Description: Closes the connection to the module

---

### Write to Info register:

void SetModullInfo ([byte](#) type, [string](#) info)  
Parameter: type: Info Type (see manual)  
                  info: Info string with up to 16 characters  
Description: writes to the information registers

Info Area	Info Byte
UserA	0
UserB	1

---

### Read Info Register:

[string](#) GetModullInfo([byte](#) type)  
Parameter: type: Info-Typ (see manual)  
Returned values: Returns the register "type" as a string  
Description: Reads the Module Information Register

Info Area	Info Byte
UserA	0
UserB	1
Hardware Identifier	3
Serial Number	4

## Write to LCD Register UserLCD:

void SetUserLCD([byte](#) line, [string](#) text)

Parameter:                    *line*: 0 = 1st line / 1 = 2nd line  
                                  *text*: LCD text up to 16 characters long

Description:                 Writes to the UserLCD registers. The parameter *line* determines the line (0 or 1) and *text* the text of 16 characters.

---

## Write to LCD-Register UserLCDm:

void SetUserLCDm([byte](#) line, [string](#) text)

Parameter:                    *line*: 0 = 1st line / 1 = 2nd line  
                                  *text*: LCD text up to 16 characters long

Description:                 Writes to the UserLCDm registers. The parameter *line* determines the line (0 or 1) and *text* the text of 16 characters.

---

## Write the LCD-Modes:

void SetLCDMode([byte](#) mode)

Parameter:                    *mode*: LCD mode  
Description:                 sets the LCD mode

LCD Mode	LCD Mode Byte
IO Mode	0
User Mode	1

**Read the LCD Mode:**[byte](#) GetLCDMode()

Returned values: LCD-Modus

Description: Reads the LCD mode

LCD Mode	LCD Mode Byte
IO Mode	0
User Mode	1

---

**Write the LCD Contrast Value:**void SetLCDContrast([ushort](#) contrast)Parameter: contrast: Values between 0 and 4095  
(recommended 800 to 1800)

Description: Sets the LCD contrast

---

**Read the LCD Contrast Value:**[ushort](#) GetLCDContrast()

Returned values: LCD contrast

Description: Reads the LCD contrast

## Read the Optocoupler outputs:

[uint](#) GetOptoOut()

Returned values: State of the optocoupler outputs

Description: Reads the state of the optocoupler outputs

---

## Write the Optocoupler outputs:

void SetOptoOut([uint](#) value)

Parameter: *value*: state of the outputs

Description: Sets the optocoupler outputs

---

## Read the Optocoupler inputs:

[uint](#) GetOptoIn()

Returned values: current state of the optocoupler inputs

Description: Reads the current state of the optocoupler inputs

---

## Start Counter:

void StartCounter([byte](#) index)

Parameter: *index*: Counter index

Description: Starts the counter with the number index

---

## Stop Counter:

void StopCounter([byte](#) index)

Parameter: *index*: Counter index

Description: Stops the counter with the number index

---



**Reset Counter:**

void ResetCounter([byte](#) *index*)

Parameter: *index*: Counter index

Description: Sets the counter reading of the counter with the number *index* back to 0

---

**Read Counter:**

[uint](#) ReadCounter([byte](#) *index*)

Parameter: *index*: Counter index

Returned values: Counter reading

Description: Reads the counter reading of the counter with the number *index*

---

**Read Overflow Flag:**

[bool](#) ReadOverflowFlagCounter([byte](#) *index*)

Parameter: *index*: Counter index

Returned values: Overflow flag false = no Overflow  
true = Overflow

Description: Reads the Overflow Flag of the counter with the number *index*

---

**Reset Overflow Flag:**

void ResetOverflowFlagCounter([byte](#) *index*)

Parameter: *index*: Counter index

Description: Resets the Overflow Flag of the counter with the number *index*

---

## AD Single Measurement:

`int` GetADC(`byte` channel, `byte` range)

Parameter: *channel*: Channel  
*range*: Measurement range

Returned values: Measured value in  $\mu\text{V}$

Description: Performs an ADC measurement.

### Channel:

Channel	Channel byte
Single Ended	
AIN00	0
AIN01	1
AIN02	2
AIN03	3
AIN04	4
AIN05	5
AIN06	6
AIN07	7
Differential measuring	
AIN00+ / AIN01-	8
AIN00- / AIN01+	9
AIN02+ / AIN03-	10
AIN02- / AIN03+	11
AIN04+ / AIN05-	12
AIN04- / AIN05+	13
AIN06+ / AIN07-	14
AIN06- / AIN07+	15

### Measuring range:

Range byte	Voltage
0	+/- 20.4V (Differential measuring only max +/- 10.2V → GND)
1	+/-10.2V
2	+/- 5.1V
3	+/-2,55V
4	+/-1.27V
5	+/- 0.63V

## AD Single measurement averaging 32 measurements:

public [int](#) GetADC\_Mean([byte](#) channel, [byte](#) range)

Element of [EXDUL.EXDUL581](#)

Parameter: *channel*: Channel  
*range*: Measurement range

Returned values: Measured value in  $\mu\text{V}$

Description: Performs an ADC measurement averaging 32 single measurements.

### Channel:

Channel	Channel byte
Single Ended	
AIN00	0
AIN01	1
AIN02	2
AIN03	3
AIN04	4
AIN05	5
AIN06	6
AIN07	7
Differential measuring	
AIN00+ / AIN01-	8
AIN00- / AIN01+	9
AIN02+ / AIN03-	10
AIN02- / AIN03+	11
AIN04+ / AIN05-	12
AIN04- / AIN05+	13
AIN06+ / AIN07-	14
AIN06- / AIN07+	15

### Measuring range:

Range byte	Voltage
0	+/- 20.4V (Differential measuring only max +/- 10.2V → GND)
1	+/-10.2V
2	+/- 5.1V
3	+/-2,55V
4	+/-1.27V
5	+/- 0.63V

## AD block measurement with averaging:

[int\[\]](#) GetADC\_BlockMean([EXDUL.ADC CHANNEL CONFIG 1\[\]](#) config)

Parameter: *config*:

Returned values: Measured value in  $\mu\text{V}$

Description: Performs an ADC block measurement over several channels (see manual)

### Channel:

Channel	Channel byte
Single Ended	
AIN00	0
AIN01	1
AIN02	2
AIN03	3
AIN04	4
AIN05	5
AIN06	6
AIN07	7
Differential measuring	
AIN00+ / AIN01-	8
AIN00- / AIN01+	9
AIN02+ / AIN03-	10
AIN02- / AIN03+	11
AIN04+ / AIN05-	12
AIN04- / AIN05+	13
AIN06+ / AIN07-	14
AIN06- / AIN07+	15

### Measuring range:

Range byte	Voltage
0	+/- 20.4V (Differential measuring only max +/- 10.2V → GND)
1	+/- 10.2V
2	+/- 5.1V
3	+/- 2.55V
4	+/- 1.27V
5	+/- 0.63V

## Reset ADC-FIFO:

void ResetFIFO()

Description

This command performs a reset of the FIFO. This should be done after an overflow.

---

## Read ADC-FIFO Overflow flag:

bool ReadOverflowFlagFIFO()

Returned values:

Overflowflag false = no Overflow / true = Overflow

Description:

Reads the overflow flag of the ADC FIFO. Along with the readout, the overflow flag is reset automatically.

---

## Readout ADC-FIFO:

int[] ReadFIFO()

Returned values:

Returns an array with the measured values. The size of the array depends on the number of measurements

Description:

Reads the ADC-FIFO

---

## AD Multiple Measurement

`int[] GetADC_Multi(ushort counts, uint samplerate, EXDUL\_ADC\_CHANNEL\_CONFIG 1\[\] config)`

Parameter: *counts*: number of measurements  
*samplerate*: sampling rate  
*config*: channel configurations

Returned values: Measured value in  $\mu\text{V}$

Description: performs an ADC multiple measurement over one or more channels. The measured values can be retrieved by the function ReadFIFO.

### Channel:

Channel	Channel byte
Single Ended	
AIN00	0
AIN01	1
AIN02	2
AIN03	3
AIN04	4
AIN05	5
AIN06	6
AIN07	7
Differential measuring	
AIN00+ / AIN01-	8
AIN00- / AIN01+	9
AIN02+ / AIN03-	10
AIN02- / AIN03+	11
AIN04+ / AIN05-	12
AIN04- / AIN05+	13
AIN06+ / AIN07-	14
AIN06- / AIN07+	15

### Measuring range:

Range byte	Voltage
0	+/- 20.4V (Differential measuring only max +/- 10.2V → GND)
1	+/-10.2V
2	+/- 5.1V
3	+/-2,55V
4	+/-1.27V
5	+/- 0.63V

## Start AD Continuous sampling

void StartADC([uint samplerate](#),  
[EXDUL\\_ADC\\_CHANNEL\\_CONFIG 1\[\]](#)config)

Parameter: *samplerate*: sampling rate  
*config*: channel configurations

Description: Starts an ADC continuous sampling over one or more channels. The measured values can be retrieved by the function ReadFIFO. The function StopADC is needed to stop the continuous sampling.

### Channel:

Channel	Channel byte
Single Ended	
AIN00	0
AIN01	1
AIN02	2
AIN03	3
AIN04	4
AIN05	5
AIN06	6
AIN07	7
Differential measuring	
AIN00+ / AIN01-	8
AIN00- / AIN01+	9
AIN02+ / AIN03-	10
AIN02- / AIN03+	11
AIN04+ / AIN05-	12
AIN04- / AIN05+	13
AIN06+ / AIN07-	14
AIN06- / AIN07+	15

### Measuring range:

Range byte	Voltage
0	+/- 20.4V (Differential measuring only max +/- 10.2V → GND)
1	+/-10.2V
2	+/- 5.1V
3	+/-2,55V
4	+/-1.27V
5	+/- 0.63V

**Stop AD Continuous Sampling**

void StopADC()

Description: Ends an ADC continuous sampling

---

**Factory Reset:**

void DefaultReset()

Description: Resets the module to the factory settings. After this command the module has to be shut down and restarted again.



## 11.4 Programming with TCP-Libraries

Due to the access to the module via standard TCP/IP socket libraries, you can program your application across a variety of languages on different platforms. So under Windows, you can use Delphi or Java besides the .Net Framework. Also on Linux based operation systems like C or Java applications can be designed. Please pay attention to your module acting as a server. .

### 11.4.1 Communicating with the EXDUL-581

Data is exchanged by transmitting or receiving byte arrays of variable length via the TCP/IP interface.

Each permitted transmission string is replied by a defined result or confirmation string.

The last result or confirmation string has to be read before transmitting a new string.

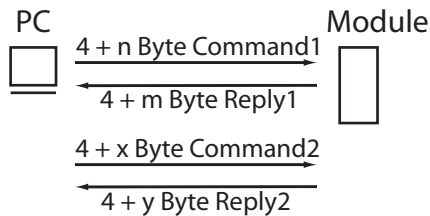

Fig. 11.2 Communication model

### 11.4.2 Command and Data Format

Data is exchanged by transmitting and receiving byte arrays. Each byte array to be transmitted or received consists of at least 4 bytes. The first three bytes represent the command and the fourth byte indicates the number of the following 4 byte blocks.

Command Byte 0	Command Byte 1	Command Byte 2	Length Byte
-------------------	-------------------	-------------------	-------------

The number of the 4 byte blocks varies from command to command and depends in part on the volume of data to be transmitted. More detailed information can be found in the individual command descriptions.

### 11.4.3 Password protection

In order to protect the module from unauthorized access, a simple password protection can be used for data exchange. If this is activated (see security configuration command), the correct password (+8 Bytes) has to be appended to each transmitted byte array. If the password is wrong or it has not been added to the command string, an error reply will be returned. The response of the command remains unchanged.

Example: writing optocoupler outputs with activated password protection and default password „11111111“

Byte	Transmitting	Receiving	Representing
0	08	08	Command code 1st Byte
1	00	00	Command code 2nd Byte
2	00	00	Command code 3rd Byte
3	03 (→ 12Byte)	00	Length prefix byte
4	00		r/w Byte
5	0w 00 (locked) 01 (enabled)		Optocoupler state
6	00		reserved
7	00		reserved
8	31 <sub>hex</sub>		Password 1st character 1 <sub>ascii</sub>
9	31 <sub>hex</sub>		Password 2nd character 1 <sub>ascii</sub>
10	31 <sub>hex</sub>		Password 3rd character 1 <sub>ascii</sub>
11	31 <sub>hex</sub>		Password 4th character 1 <sub>ascii</sub>
12	31 <sub>hex</sub>		Password 5th character 1 <sub>ascii</sub>
13	31 <sub>hex</sub>		Password 6th character 1 <sub>ascii</sub>
14	31 <sub>hex</sub>		Password 7th character 1 <sub>ascii</sub>
15	31 <sub>hex</sub>		Password 8th character 1 <sub>ascii</sub>

The regular command without password protection contains of 8 bytes only, and in the length prefix byte the value is 1. As shown in the above table, now 8 more bytes have been appended holding the password. Additionally, the length byte has to be increased by 2 (+8 bytes). The response does not contain a password and corresponds to the usual response array without a password.

## 11.4.4 Command overview

Hexcode	Representing
0C 00 00	Read and write info register
0C 00 03	Read and write LCD register
0C 00 08	Read and write network configuration
0C 00 0C	Read and write security configuration
0C 00 0D	Change password
08 00 00	Read and write optocoupler outputs
08 00 01	Edit optocoupler inputs
0A 00 00	AD Single measurement
0A 00 01	AD Single measurement with averaging
0A 00 02	AD block measurement with averaging
0A 00 06	ADC FIFO Reset
0A 00 07	ADC FIFO read out overflow flag
0A 00 08	Read out ADC FIFO
0A 00 09	AD Multiple measurement
0A 00 0A	Start AD continuous sampling
0A 00 0B	Stop AD continuous sampling
09 00 00	Counter0
09 00 01	Counter1
09 00 02	Counter2
09 00 03	Counter3
09 00 04	Counter4

## 11.4.5 Structure of commands

### Writing into the info registers

The EXDUL module provides several writable information registers. UserA/B are two 16-byte areas for the user to store information into a non-volatile memory (FLASH). The registers are writable only as a whole 16-byte block.

Info area	Info Byte
UserA	0
UserB	1

Example: enter the character string EXDUL-581 into register UserA and UserB

Byte	Transmit	Receive	Representing
0	0C	0C	Command code 1st Byte
1	00	00	Command code 2nd Byte
2	00	00	Command code 3rd Byte
3	05	00	Lenght prefix byte => 20 Byte
4	00 (UserA) 01 (UserB)		Info byte
5	00		reserved
6	00		reserved
7	00		Info area of write operation
8	45		Data 1st character E <sub>ASCII</sub>
9	58		Data 2nd character X <sub>ASCII</sub>
10	44		Data 3rd character D <sub>ASCII</sub>
11	55		Data 4th character U <sub>ASCII</sub>
12	4C		Data 5th character L <sub>ASCII</sub>
13	2D		Data 6th character - <sub>ASCII</sub>
14	35		Data 7th character 5 <sub>ASCII</sub>
15	38		Data 8th character 8 <sub>ASCII</sub>
16	31		Data 9th character 1 <sub>ASCII</sub>
17	20		Data 10th character [blank] <sub>ASCII</sub>
18	20		Data 11th character [blank] <sub>ASCII</sub>
19	20		Data 12th character [blank] <sub>ASCII</sub>
20	20		Data 13th character [blank] <sub>ASCII</sub>
21	20		Data 14th character [blank] <sub>ASCII</sub>
22	20		Data 15th character [blank] <sub>ASCII</sub>
23	20		Data 16th character [blank] <sub>ASCII</sub>

## Reading from the information registers

The EXDUL module provides several 16-byte wide information areas which hold module information such as serial number or Hardware identifier. Additionally, the user can also read out the writable user registers.

Info Area	Info Byte
UserA	0
UserB	1
Hardware ID	3
Serial Number	4

Information: All of the information areas can only be read as a whole 16-byte block.

Example: Read information area UserA (User string = „EXDUL-581“)

An 8-byte block is transmitted and a 20-byte block is received with content from UserA or UserB

Byte	Transmit	Representing	Receive	Representing
0	0C	Command code 1st Byte	0C	Command code 1st Byte
1	00	Command code 2nd Byte	00	Command code 2nd Byte
2	00	Command code 3rd Byte	00	Command code 3rd Byte
3	01	Length byte → 4Byte	04	Length byte → 16 Byte
4	00 (UserA) 01 (UserB)	Information byte	45	Data 1st character E <sub>ascii</sub>
5	00	reserved	58	Data 2nd character X <sub>ascii</sub>
6	00	reserved	44	Data 3rd character D <sub>ascii</sub>
7	01	Read function info area	55	Data 4th character U <sub>ascii</sub>
8			4C	Data 5th character L <sub>ascii</sub>
9			2D	Data 6th character r <sub>ascii</sub>
10			35	Data 7th character 5 <sub>ascii</sub>
11			38	Data 8th character 8 <sub>ascii</sub>
12			31	Data 9th character 1 <sub>ascii</sub>
13			20	Data 10th character [blank] <sub>ascii</sub>
14			20	Data 11th character [blank] <sub>ascii</sub>
15			20	Data 12th character [blank] <sub>ascii</sub>
16			20	Data 13th character [blank] <sub>ascii</sub>
17			20	Data 14th character [blank] <sub>ascii</sub>
18			20	Data 15th character [blank] <sub>ascii</sub>
19			20	Data 16th character [blank] <sub>ascii</sub>

Example: Read out information area hardware identifier

An 8-byte block is transmitted and a 20-byte block is received with hardware identifier

Byte	Transmit	Representing	Receive	Representing
0	0C	Command code 1st Byte	0C	Command code 1st Byte
1	00	Command code 2nd Byte	00	Command code 2nd Byte
2	00	Command code 3rd Byte	00	Command code 3rd Byte
3	01	Length byte → 4Byte	04	Length byte → 16 Byte
4	04	Information byte	45	Data 1st character E <sub>ASCII</sub>
5	00	reserved	58	Data 2nd character X <sub>ASCII</sub>
6	00	reserved	44	Data 3rd character D <sub>ASCII</sub>
7	01	Read function info area	55	Data 4th character U <sub>ASCII</sub>
8			4C	Data 5th character L <sub>ASCII</sub>
9			2D	Data 6th character ° <sub>ASCII</sub>
10			35	Data 7th character 5 <sub>ASCII</sub>
11			38	Data 8th character 8 <sub>ASCII</sub>
12			31	Data 9th character 1 <sub>ASCII</sub>
13			20	Data 10th character [blank] <sub>ASCII</sub>
14			20	Data 11th character [blank] <sub>ASCII</sub>
15			20	Data 12th character [blank] <sub>ASCII</sub>
16			20	Data 13th character [blank] <sub>ASCII</sub>
17			20	Data 14th character [blank] <sub>ASCII</sub>
18			20	Data 15th character [blank] <sub>ASCII</sub>
19			20	Data 16th character [blank] <sub>ASCII</sub>

Example: Read out information area serial number

An 8-byte block is transmitted and a 20-byte block is received with serial number

Byte	Transmit	Representing	Receive	Representing
0	0C	Command code 1st Byte	0C	Command code 1st Byte
1	00	Command code 2nd Byte	00	Command code 2nd Byte
2	00	Command code 3rd Byte	00	Command code 3rd Byte
3	01	Length byte → 4Byte	03	Length byte → 16 Byte
4	04	Information byte	31	Data 1st character 1 <sub>dez</sub>
5	00	reserved	30	Data 2nd character 0 <sub>dez</sub>
6	00	reserved	34	Data 3rd character 4 <sub>dez</sub>
7	01	Read function info area	34	Data 4th character 4 <sub>dez</sub>
8			30	Data 5th character 0 <sub>dez</sub>
9			32	Data 6th character 2 <sub>dez</sub>
10			36	Data 7th character 6 <sub>dez</sub>
11				reserved
12				reserved
13				reserved
14				reserved
15				reserved
16				reserved
17				reserved
18				reserved
19				reserved



## Writing into LCD registers

The EXDUL module provides several writable LCD registers. UserLCD1 and UserLCD2 correspond to the two lines when using UserMode LCD display. UserLCD1m and UserLCD2m are two 16 byte wide areas, which are stored directly to a non-volatile memory (FLASH) and are loaded into the registers UserLCD1m or UserLCD2m at module start. All of the registers are writable as a whole 16-byte block only.

LCD Command	LCD Command Byte
UserLCD1	0
UserLCD2	1
UserLCD1m	2
UserLCD2m	3

Example: enter the character string EXDUL-581 to the register

Byte	Transmit	Receive	Representing
0	0C	0C	Command code 1st Byte
1	00	00	Command code 2nd Byte
2	03	03	Command code 3rd Byte
3	05	00	Lenght prefix byte => 20 Byte
4	00 (UserLCD1) 01 (UserLCD2) 02 (UserLCD1m) 03 (UserLCD2m)		LCD command
5	00		reserved
6	00		reserved
7	00		write operation
8	45		Data 1st character E <sub>ASCII</sub>
9	58		Data 2nd character X <sub>ASCII</sub>
10	44		Data 3rd character D <sub>ASCII</sub>
11	55		Data 4th character U <sub>ASCII</sub>
12	4C		Data 5th character L <sub>ASCII</sub>
13	2D		Data 6th character - <sub>ASCII</sub>
14	35		Data 7th character 5 <sub>ASCII</sub>
15	38		Data 8th character 8 <sub>ASCII</sub>
16	31		Data 9th character 1 <sub>ASCII</sub>
17	20		Data 10th character [blank] <sub>ASCII</sub>
18	20		Data 11th character [blank] <sub>ASCII</sub>
19	20		Data 12th character [blank] <sub>ASCII</sub>
20	20		Data 13th character [blank] <sub>ASCII</sub>
21	20		Data 14th character [blank] <sub>ASCII</sub>
22	20		Data 15th character [blank] <sub>ASCII</sub>
23	20		Data 16th character [blank] <sub>ASCII</sub>

### Reading from LCD registers

The EXDUL module provides several writable and readable LCD registers. UserLCD1 and UserLCD2 correspond to the two lines when using UserMode LCD display. UserLCD1m and UserLCD2m are two 16-byte areas, which are stored directly in a non-volatile memory (FLASH) and are loaded into the registers UserLCD1m or UserLCD2m at module start. All of the registers are readable as whole 16-byte blocks only.

LCD Command	LCD Command Byte
UserLCD1 & UserLCD2	0
UserLCD1m & UserLCD2m	2

Example: reading the character string EXDUL-581 from register

Byte	Transmit	Representing	Receive	Representing
0	0C	Command code 1st Byte	0C	Command code 1st Byte
1	00	Command code 2nd Byte	00	Command code 2nd Byte
2	03	Command code 3rd Byte	03	Command code 3rd Byte
3	01	Length byte → 20 Byte	08	Length byte → 20 Byte
4	00 (UserLCD1&2) 02 (UserLCD1m&2m)	LCD Command	45	Data Line1 1st character E <sub>ascii</sub>
5	00	reserved	58	Data Line1 2nd character X <sub>ascii</sub>
6	00	reserved	44	Data Line1 3rd character D <sub>ascii</sub>
7	01	Read function LCD registers	55	Data Line1 4th character U <sub>ascii</sub>
8			4C	Data Line1 5th character L <sub>ascii</sub>
9			2D	Data Line1 6th character ^ <sub>ascii</sub>
10			35	Data Line1 7th character 5 <sub>ascii</sub>
11			38	Data Line1 8th character 8 <sub>ascii</sub>
12			31	Data Line1 9th character 1 <sub>ascii</sub>
13			20	Data Line1 10th character [blank] <sub>ascii</sub>
14			20	Data Line1 11th character [blank] <sub>ascii</sub>
15			20	Data Line1 12th character [blank] <sub>ascii</sub>
16			20	Data Line1 13th character [blank] <sub>ascii</sub>
17			20	Data Line1 14th character [blank] <sub>ascii</sub>
18			20	Data Line1 15th character [blank] <sub>ascii</sub>
19			20	Data Line1 16th character [blank] <sub>ascii</sub>
20			45	Data Line2 1st character E <sub>ascii</sub>
21			58	Data Line2 2nd character X <sub>ascii</sub>
22			44	Data Line2 3rd character D <sub>ascii</sub>
23			55	Data Line2 4th character U <sub>ascii</sub>
24			4C	Data Line2 5th character L <sub>ascii</sub>
25			2D	Data Line2 6th character ^ <sub>ascii</sub>
26			35	Data Line2 7th character 5 <sub>ascii</sub>
27			38	Data Line2 8th character 8 <sub>ascii</sub>
28			31	Data Line2 9th character 1 <sub>ascii</sub>
29			20	Data Line2 10th character [blank] <sub>ascii</sub>
30			20	Data Line2 11th character [blank] <sub>ascii</sub>
31			20	Data Line2 12th character [blank] <sub>ascii</sub>
32			20	Data Line2 13th character [blank] <sub>ascii</sub>
33			20	Data Line2 14th character [blank] <sub>ascii</sub>
34			20	Data Line2 15th character [blank] <sub>ascii</sub>
35			20	Data Line2 16th character [blank] <sub>ascii</sub>

## Writing the LCD Mode

The module's LCD display provides several display modes. These can be set by the following command. The LCD mode is stored in a non-volatile memory and is also employed after a restart of the module.

LCD Mode	LCD Mode Byte
I/O Mode	0
User Mode	1

Example: writing the LCD Mode

Byte	Transmit	Representing	Receive	Representing
0	0C	Command code 1st Byte	0C	Command code 1st Byte
1	00	Command code 2nd Byte	00	Command code 2nd Byte
2	03	Command code 3rd Byte	03	Command code 3rd Byte
3	02	Length byte → 8 Byte	00	Length byte → 0 Byte
4	04	LCD Command LCD mode		
5	00	reserved		
6	00	reserved		
7	00	Write function		
8	00 (IO Mode) 01 (User Mode)	LCD mode		
9	00	reserved		
10	00	reserved		
11	00	reserved		

### Reading the LCD Mode

The module's LCD display provides several modes of display. The set LCD mode can be read out by following command.

LCD Mode	LCD Mode Byte
I/O Mode	0
User Mode	1

Example: reading the LCD Mode

Byte	Transmit	Representing	Receive	Representing
0	0C	Command code 1st Byte	0C	Command code 1st Byte
1	00	Command code 2nd Byte	00	Command code 2nd Byte
2	03	Command code 3rd Byte	03	Command code 3rd Byte
3	01	Length byte → 4 Byte	01	Length byte → 4 Byte
4	04	LCD command LCD mode	00 (IO-Mode) 01 (User-Mode)	LCD mode
5	00	reserved	00	reserved
6	00	reserved	00	reserved
7	01	read function	00	reserved

## Writing the LCD contrast value

This command is used to adjust the display contrast. Values between 0 and 4095 are accepted. The display contrast decreases with increasing values. A comfortable display is achieved in the range 800 to 1800.

Example: writing display contrast value 800

Byte	Transmit	Representing	Receive	Representing
0	0C	Command code 1st Byte	0C	Command code 1st Byte
1	00	Command code 2nd Byte	00	Command code 2nd Byte
2	03	Command code 3rd Byte	03	Command code 3rd Byte
3	02	Length byte → 8 Byte	00	Length byte → 0 Byte
4	0B	LCD command LCD contrast		
5	00	reserved		
6	00	reserved		
7	00	write function		
8	50	Contrast value (Lowbyte - 00...FF)		
9	03	Contrast value (Highbyte - 00...0F)		
10	00	reserved		
11	00	reserved		

## Reading the LCD contrast value

This command is used to read out the display contrast. The value can be between 0 and 4095. The display contrast decreases with increasing values. A comfortable display is achieved in the range 800 to 1800.

Example: reading display contrast value 800

Byte	Transmit	Representing	Receive	Representing
0	0C	Command code 1st Byte	0C	Command code 1st Byte
1	00	Command code 2nd Byte	00	Command code 2nd Byte
2	03	Command code 3rd Byte	03	Command code 3rd Byte
3	01	Length byte → 4 Byte	01	Length byte → 4 Byte
4	0B	LCD command LCD contrast	50	Contrast value (Lowbyte - 00...FF)
5	00	reserved	03	Contrast value (Highbyte - 00...0F)
6	00	reserved	00	reserved
7	01	read function	00	reserved

## Writing the network configuration

This command is used to modify all of the network configurations such as IP address, subnet mask, hostname, Gateway, DNS addresses and the setting of the DHCP client function.

Example: writing the network configuration

Hostname = „EXDUL-581“, IP = 192.168.0.63, Subnet mask = 255.255.255.0,

Gateway = 192.168.0.1, Primary DNS = 192.168.0.1, Secondary DNS = 217.237.151.115

Byte	Transmit	Representing	Receive	Representing
0	0C	Command code 1st Byte	0C	Command code 1st Byte
1	00	Command code 2nd Byte	00	Command code 2nd Byte
2	08	Command code 3rd Byte	08	Command code 3rd Byte
3	0B	Length byte → 44 Byte	00	Length byte → 0 Byte
4	00	reserved		
5	00	reserved		
6	00	reserved		
7	00	write function		
8	45	Hostname 1st character E <sub>ASCII</sub>		
9	58	Hostname 2nd character X <sub>ASCII</sub>		
10	44	Hostname 3rd character D <sub>ASCII</sub>		
11	55	Hostname 4th character U <sub>ASCII</sub>		
12	4C	Hostname 5th character L <sub>ASCII</sub>		
13	2D	Hostname 6th character * <sub>ASCII</sub>		
14	35	Hostname 7th character 5 <sub>ASCII</sub>		
15	38	Hostname 8th character 8 <sub>ASCII</sub>		
16	31	Hostname 9th character 1 <sub>ASCII</sub>		
17	20	Hostname 10th character [blank] <sub>ASCII</sub>		
18	20	Hostname 11th character [blank] <sub>ASCII</sub>		
19	20	Hostname 12th character [blank] <sub>ASCII</sub>		
20	20	Hostname 13th character [blank] <sub>ASCII</sub>		
21	20	Hostname 14th character [blank] <sub>ASCII</sub>		
22	20	Hostname 15th character [blank] <sub>ASCII</sub>		
23	20	Hostname 16th character [blank] <sub>ASCII</sub>		
24	3F	4th Byte IP address decimal value 63		
25	0	3rd Byte IP address decimal value 0		
26	A8	2nd Byte IP address decimal value 168		
27	C0	1st Byte IP address decimal value 192		

28	00	4th Byte Subnetmask decimal value 0		
29	FF	3rd Byte Subnetmask decimal value 255		
30	FF	2nd Byte Subnetmask decimal value 255		
31	FF	1st Byte Subnetmask decimal value 255		
32	01	Gateway 4th Byte decimal value 1		
33	00	Gateway 3rd Byte decimal value 0		
34	A8	Gateway 2nd Byte decimal value 168		
35	C0	Gateway 1th Byte decimal value 192		
36	01	Primary DNS 4th Byte decimal value 1		
37	00	Primary DNS 3rd Byte decimal value 0		
38	A8	Primary DNS 2nd Byte decimal value 168		
39	C0	Primary DNS 1st Byte decimal value 192		
40	73	Secondary DNS 4th Byte decimal value 115		
41	97	Secondary DNS 3rd Byte decimal value 151		
42	ED	Secondary DNS 2nd Byte decimal value 237		
43	D9	Secondary DNS 1st Byte decimal value 217		
44	0w 00 (DHCP disable) 01 (DHCP enable)	DCHP client configuration		
45	00	reserved		
46	00	reserved		
47	00	reserved		



## Reading the network configuration

This command is used to read all of the network configurations such as IP address, subnet mask, hostname, Gateway, DNS addresses and the setting of the DHCP client function or MAC address.

Example: reading the network configuration

Hostname = „EXDUL-581“, IP = 192.168.0.63, Subnet mask = 255.255.255.0,

Gateway = 192.168.0.1, Primary DNS = 192.168.0.1, Secondary DNS = 217.237.151.115

Byte	Transmit	Representing	Receive	Representing
0	0C	Command code 1st Byte	0C	Command code 1st Byte
1	00	Command code 2nd Byte	00	Command code 2nd Byte
2	08	Command code 3rd Byte	08	Command code 3rd Byte
3	01	Length byte → 4 Byte	0C	Length byte → 48 Byte
4	00	reserved	45	Hostname 1st character E <sub>ASCII</sub>
5	00	reserved	58	Hostname 2nd character X <sub>ASCII</sub>
6	00	reserved	44	Hostname 3rd character D <sub>ASCII</sub>
7	01	Read function	55	Hostname 4th character U <sub>ASCII</sub>
8			4C	Hostname 5th character L <sub>ASCII</sub>
9			2D	Hostname 6th character ~ <sub>ASCII</sub>
10			35	Hostname 7th character 5 <sub>ASCII</sub>
11			38	Hostname 8th character 8 <sub>ASCII</sub>
12			31	Hostname 9th character 1 <sub>ASCII</sub>
13			20	Hostname 10th character [blank] <sub>ASCII</sub>
14			20	Hostname 11th character [blank] <sub>ASCII</sub>
15			20	Hostname 12th character [blank] <sub>ASCII</sub>
16			20	Hostname 13th character [blank] <sub>ASCII</sub>
17			20	Hostname 14th character [blank] <sub>ASCII</sub>
18			20	Hostname 15th character [blank] <sub>ASCII</sub>
19			20	Hostname 16th character [blank] <sub>ASCII</sub>
20			3F	4th Byte IP address decimal value 63
21			0	3rd Byte IP address decimal value 0
22			A8	2nd Byte IP address decimal value 168
23			C0	1st Byte IP address decimal value 192
24			00	4th Byte Subnetmask decimal value 0
25			FF	3rd Byte Subnetmask decimal value 255
26			FF	2nd Byte Subnetmask decimal value 255
27			FF	1st Byte Subnetmask decimal value 255

28			01	Gateway 4th Byte decimal value 1
29			00	Gateway 3rd Byte decimal value 0
30			A8	Gateway 2nd Byte decimal value 168
31			C0	Gateway 1th Byte decimal value 192
32			01	Primary DNS 4th Byte decimal value 1
33			00	Primary DNS 3rd Byte decimal value 0
34			A8	Primary DNS 2nd Byte decimal value 168
35			C0	Primary DNS 1st Byte decimal value 192
36			73	Secondary DNS 4th Byte decimal value 115
37			97	Secondary DNS 3rd Byte decimal value 151
38			ED	Secondary DNS 2nd Byte decimal value 237
39			D9	Secondary DNS 1st Byte decimal value 217
40			0w 00 (DHCP disable) 01 (DHCP enable)	DCHP client Configuration
41			00	Reserved
42			00	Reserved
43			00	Reserved
44				Reserved
45				Reserved
46			00	MAC address 6th character
47			00	MAC address 5th character
AA			00	MAC address 4th character
49			3E	MAC address 3rd character
50			B4	MAC address 2nd character
51			D4	MAC address 1st character

## Writing of the security configuration

The EXDUL module features a password protection for secure communication. If this is activated, each transfer to the module requires the correct password. It is deactivated in default state.

Security configuration	Security Byte
Password deactivated	0
Password activated	1

Example: writing the security configuration

Byte	Transmit	Receive	Representing
0	0C	0C	Command code 1st Byte
1	00	00	Command code 2nd Byte
2	0C	0C	Command code 3rd Byte
3	01	01	Length byte → 20 Byte
4	00 (Password deactivated) 01 (Password activated)		Security Byte
5	00		reserved
6	00		reserved
7	00		Write function Security configuration

## Reading the Security configuration

The EXDUL module features a password protection for secure communication. If this is activated, each transfer to the module requires the correct password. It is deactivated in default state.

Security configuration	Security Byte
Password deactivated	0
Password activated	1

Example: Reading the security configuration

Byte	Transmit	Receive	Representing
0	0C	0C	Command code 1st Byte
1	00	00	Command code 2nd Byte
2	0C	0C	Command code 3rd Byte
3	01	01	Length byte → 20 Byte
4	00	00 (Password deactivated) 01 (Password activated)	Security Byte
5	00	00	reserved
6	00	00	reserved
7	01	00	Read function Security configuration

### Changing the Access Code (Password)

The EXDUL module features a password protection for secure communication. If this is activated, each transfer to the module requires the correct password. In default state the password is „11111111“ in ASCII and corresponds to that of the web page. This function is used to change the password.

Example: changing the password to „EXDUL581“

Byte	Transmit	Receive	Representing
0	0C	0C	Command code 1st Byte
1	00	00	Command code 2nd Byte
2	0D	0D	Command code 3rd Byte
3	02	00	Length byte → 20 Byte
4	45 <sub>hex</sub>		Password 1st character E <sub>ascii</sub>
5	58 <sub>hex</sub>		Password 2nd character X <sub>ascii</sub>
6	44 <sub>hex</sub>		Password 3rd character D <sub>ascii</sub>
7	55 <sub>hex</sub>		Password 4th character U <sub>ascii</sub>
8	4C <sub>hex</sub>		Password 5th character L <sub>ascii</sub>
9	35 <sub>hex</sub>		Password 6th character 5 <sub>ascii</sub>
10	38 <sub>hex</sub>		Password 7th character 8 <sub>ascii</sub>
11	31 <sub>hex</sub>		Password 8th character 1 <sub>ascii</sub>

## Reading the Optocoupler Output Port

This command is used to read the current state of the optocoupler output.  
Optocoupler enabled = 1, optocoupler disabled = 0

Example: reading the optocoupler output state

An 8-byte block is transmitted and an 8-byte block is received holding the current optocoupler output state

Output channel	DOUT1	DOUT0
Screw terminal	22	21
Switching state	1	0

Byte	Transmit	Representing	Receive	Representing
0	08	Command code 1st Byte	08	Command code 1st Byte
1	00	Command code 2nd Byte	00	Command code 2nd Byte
2	00	Command code 3rd Byte	00	Command code 3rd Byte
3	01 (→ 4Byte)	Length byte	01 (→ 4Byte)	Length byte
4	01	r/w Byte (1→ read)	01	Read function
5	00	reserved	02	optocoupler output state
6	00	reserved	00	reserved
7	00	reserved	00	reserved

## Writing the Optocoupler Output Port

This command is used to disable or to enable the output optocoupler  
Optocoupler enabled = 1, optocoupler disabled = 0

Example: output the state (0x02<sub>hex</sub>) at the optocoupler outputs (= DOUT0 disabled and DOUT1 enabled)

An 8-byte block is transmitted and a 4-byte block is received as confirmation

Output channel	DOUT1	DOUT0
Screw terminal	22	21
Switching state	1	0

Byte	Transmit	Receive	Representing
0	08	08	Command code 1st Byte
1	00	00	Command code 2nd Byte
2	00	00	Command code 3rd Byte
3	01 (→ 4Byte)	00	Length byte
4	00		r/w Byte (0→ write)
5	02		Optocoupler output state
6	00		reserved
7	00		reserved

## Reading the Optocoupler Input Port

This command is used to read the current states of the optocoupler inputs

Example: reading the optocoupler input states

A 4-byte block is transmitted and an 8-byte block is received holding the current optocoupler input states.

Precondition for these examples is to apply input levels (here 0xB3) at the single inputs as per the following table:

(0 = LOW = 0...3V, 1 = HIGH = 10..30V)

Output channel	DIN7	DIN6	DIN5	DIN4	DIN3	DIN2	DIN1	DIN0
Screw terminal	18	17	16	15	14	13	12	11
Switching state	1	0	1	1	0	0	1	1

Byte	Transmit	Representing	Receive	Representing
0	08	Command code 1st Byte	08	Command code 1st Byte
1	00	Command code 2nd Byte	00	Command code 2nd Byte
2	01	Command code 3rd Byte	00	Command code 3rd Byte
3	00	Length byte	01 (→ 4Byte)	Length byte
4			B3	Optocoupler input state
5			00	reserved
6			00	reserved
7			00	reserved

## Counter0

This command is used to access the counters. The counter can be started, stopped, reset and read out. Furthermore, you can read in and reset the overflow flag.

Code	Counter command code
00	start counter
01	stop counter
02	reset counter
03	read counter value
04	reserved
05	read overflow flag
06	reset overflow flag

Example as for counter0:

### Counter0 Start / Stop / Reset

Byte	Transmit	Representing	Receive	Representing
0	09	Command code 1st Byte	09	Command code 1st Byte
1	00	Command code 2nd Byte	00	Command code 2nd Byte
2	00	Command code 3rd Byte	00	Command code 3rd Byte
3	01	Length byte	01	Length byte
4	bb 00 01 02	Counter command code start counter0 stop counter0 reset counter0	bb	Counter command code
5	00	reserved	00	reserved
6	00	reserved	00	reserved
7	00	reserved	00	reserved



## Reading the counter0

Byte	Transmit	Representing	Receive	Representing
0	09	Command code 1st Byte	09	Command code 1st Byte
1	00	Command code 2nd Byte	00	Command code 2nd Byte
2	00	Command code 3rd Byte	00	Command code 3rd Byte
3	01	Length byte	02 (→ 8Byte)	Length byte
4	03	Counter command code	03	Counter command code
5	00	reserved	00	reserved
6	00	reserved	00	reserved
7	00	reserved	00	reserved
8			ww	Counter value Byte0
9			ww	Counter value Byte1
10			ww	Counter value Byte2
11			ww	Counter value Byte3

Counter reading = counter status Byte3 \* 0x1000000 + counter status Byte2 \* 0x10000 + counter status Byte1 \* 0x100 + counter status Byte0

## Reading the overflow flag Counter0

Byte	Transmit	Representing	Receive	Representing
0	09	Command code 1st Byte	09	Command code 1st Byte
1	00	Command code 2nd Byte	00	Command code 2nd Byte
2	00	Command code 3rd Byte	00	Command code 3rd Byte
3	01	Length byte	02 (→ 8Byte)	Length byte
4	05	Counter command code Reading the overflow flag	05	Counter command code Reading the overflow flag
5	00	reserved	00	reserved
6	00	reserved	00	reserved
7	00	reserved	0f	overflow flag

## Reset overflow flag Counter0

Byte	Transmit	Representing	Receive	Representing
0	09	Command code 1st Byte	09	Command code 1st Byte
1	00	Command code 2nd Byte	00	Command code 2nd Byte
2	00	Command code 3rd Byte	00	Command code 3rd Byte
3	01	Length byte	01 (→ 4Byte)	Length byte
4	06	Counter command code Reset overflow flag	06	Counter command code Reset overflow flag
5	00	reserved	00	reserved
6	00	reserved	00	reserved
7	00	reserved	00	reserved

## AD Single measurement

The command AD single measurement performs a voltage measurement on a desired analog input channel and returns the value calibrated as an integer in  $\mu\text{V}$  to the computer. The command has to contain the desired channel as well as the measuring range.

Channel:

Channel	Channel byte
Single Ended	
AIN00	0
AIN01	1
AIN02	2
AIN03	3
AIN04	4
AIN05	5
AIN06	6
AIN07	7
Differential measuring	
AIN00+ / AIN01-	8
AIN00- / AIN01+	9
AIN02+ / AIN03-	10
AIN02- / AIN03+	11
AIN04+ / AIN05-	12
AIN04- / AIN05+	13
AIN06+ / AIN07-	14
AIN06- / AIN07+	15

Measuring range:

Range byte	Voltage
0	+/- 20.4V (Differential measuring only max +/- 10.2V → GND)
1	+/-10.2V
2	+/- 5.1V
3	+/-2,55V
4	+/-1.27V
5	+/- 0.63V

Example of measuring a voltage at an input signal

Byte	Transmit	Representing	Receive	Representing
0	0A	Command code 1st Byte	0A	Command code 1st Byte
1	00	Command code 2nd Byte	00	Command code 2nd Byte
2	00	Command code 3rd Byte	00	Command code 3rd Byte
3	01 (→ 4Byte)		01 (→ 4Byte)	Length byte
4	cc	Channel byte	ww	Measured value Byte0
5	bb	Range byte	ww	Measured value Byte1
6	00		ww	Measured value Byte2
7	00		ww	Measured value Byte3

Voltage = (integer) (Byte3 \* 0x1000000 + Byte2 \* 0x10000 + Byte1 \* 0x100 + Byte0) [ $\mu\text{V}$ ]

## AD Single measurement with averaging

The command AD single measurement with averaging performs 32 voltage measurements at a rate of 100kS/s on a desired analog input channel, averages it and returns the value calibrated as an integer in  $\mu\text{V}$  to the computer. The desired channel as well as the measuring range has to be transmitted to the command.

Channel:

Channel	Channel byte
Single Ended	
AIN00	0
AIN01	1
AIN02	2
AIN03	3
AIN04	4
AIN05	5
AIN06	6
AIN07	7
Differential measuring	
AIN00+ / AIN01-	8
AIN00- / AIN01+	9
AIN02+ / AIN03-	10
AIN02- / AIN03+	11
AIN04+ / AIN05-	12
AIN04- / AIN05+	13
AIN06+ / AIN07-	14
AIN06- / AIN07+	15

Measuring range:

Range byte	Voltage
0	+/- 20.4V (Differential measuring only max +/- 10.2V → GND)
1	+/-10.2V
2	+/- 5.1V
3	+/-2,55V
4	+/-1.27V
5	+/- 0.63V

Example of measuring the voltage on an input signal

Byte	Transmit	Representing	Receive	Representing
0	0A	Command code 1st Byte	0A	Command code 1st Byte
1	00	Command code 2nd Byte	00	Command code 2nd Byte
2	01	Command code 3rd Byte	01	Command code 3rd Byte
3	01 (→ 4Byte)	Length byte	01 (→ 4Byte)	Length byte
4	cc	Channel byte	ww	Measured value Byte0
5	bb	Range byte	ww	Measured value Byte1
6	00	reserved	ww	Measured value Byte2
7	00	reserved	ww	Measured value Byte3

Voltage = (integer) (Byte3 \* 0x1000000 + Byte2 \* 0x10000 + Byte1 \* 0x100 + Byte0) [ $\mu\text{V}$ ]

## AD block measurement with averaging

This command performs sampling of up to 8 channels in quick succession. Each channel to be measured is sampled 32 times, each averaged (see chapter 6.5.3) and the value returned as an integer in  $\mu\text{V}$  to the PC.

Channel:

Channel	Channel byte
Single Ended	
AIN00	0
AIN01	1
AIN02	2
AIN03	3
AIN04	4
AIN05	5
AIN06	6
AIN07	7
Differential measuring	
AIN00+ / AIN01-	8
AIN00- / AIN01+	9
AIN02+ / AIN03-	10
AIN02- / AIN03+	11
AIN04+ / AIN05-	12
AIN04- / AIN05+	13
AIN06+ / AIN07-	14
AIN06- / AIN07+	15

Measuring range:

Range byte	Voltage
0	+/- 20.4V (Differential measuring only max +/- 10.2V → GND)
1	+/-10.2V
2	+/- 5.1V
3	+/-2,55V
4	+/-1.27V
5	+/- 0.63V

Command structure  $n = 1 \dots 8$

Byte	Transmit	Representing
0	0A	Command code 1st Byte
1	00	Command code 2nd Byte
2	02	Command code 3rd Byte
3	(n*4)	Length byte (n = number of channels)
4	00	reserved
5	00	reserved
6	c <sub>0</sub> c <sub>0</sub>	Channel byte
7	b <sub>0</sub> b <sub>0</sub>	Range byte
	:	
	:	
3 + n*4	c <sub>n-1</sub> c <sub>n-1</sub>	Channel byte
4 + n*4	b <sub>n-1</sub> b <sub>n-1</sub>	Range byte

Byte	Recieve	Representing
0	0A	Command code 1st Byte
1	00	Command code 2nd Byte
2	02	Command code 3rd Byte
3	(n*4)	Length byte (n = number of channels)
4	w <sub>1</sub> w <sub>1</sub>	Measured value <sub>1</sub> Byte0 <sub>1</sub>
5	w <sub>1</sub> w <sub>1</sub>	Measured value <sub>1</sub> Byte1 <sub>1</sub>
6	w <sub>1</sub> w <sub>1</sub>	Measured value <sub>1</sub> Byte2 <sub>1</sub>
7	w <sub>1</sub> w <sub>1</sub>	Measured value <sub>1</sub> Byte3 <sub>1</sub>
	:	
	:	
3 + n*4	w <sub>n</sub> w <sub>n</sub>	Measured value <sub>n</sub> Byte0 <sub>n</sub>
4 + n*4 + 1	w <sub>n</sub> w <sub>n</sub>	Measured value <sub>n</sub> Byte1 <sub>n</sub>
4 + n*4 + 2	w <sub>n</sub> w <sub>n</sub>	Measured value <sub>n</sub> Byte2 <sub>n</sub>
4 + n*4 + 3	w <sub>n</sub> w <sub>n</sub>	Measured value <sub>n</sub> Byte3 <sub>n</sub>

Example:

In the following example, AIN01, AIN02 and AIN04 are to be sampled. The measuring range may be +/- 10.2V for all values.

Byte	Transmit	Representing	Receive	Representing
0	0A	Command code 1st Byte	0A	Command code 1st Byte
1	00	Command code 2nd Byte	00	Command code 2nd Byte
2	02	Command code 3rd Byte	02	Command code 3rd Byte
3	03 (→ 12Byte)	Length byte	03 (→ 12Byte)	Length byte
4	00	reserved	w <sub>1</sub> w <sub>1</sub>	Measured value AIN01 Byte0 <sub>1</sub>
5	00	reserved	w <sub>1</sub> w <sub>1</sub>	Measured value AIN01 Byte1 <sub>1</sub>
6	01	Channel byte AIN01	w <sub>1</sub> w <sub>1</sub>	Measured value AIN01 Byte2 <sub>1</sub>
7	01	Range byte +/- 10.2V	w <sub>1</sub> w <sub>1</sub>	Measured value AIN01 Byte3 <sub>1</sub>
8	00	reserved	w <sub>2</sub> w <sub>2</sub>	Measured value AIN02 Byte0 <sub>2</sub>
9	00	reserved	w <sub>2</sub> w <sub>2</sub>	Measured value AIN02 Byte1 <sub>2</sub>
10	02	Channel byte AIN02	w <sub>2</sub> w <sub>2</sub>	Measured value AIN02 Byte2 <sub>2</sub>
11	01	Range byte +/- 10.2V	w <sub>2</sub> w <sub>2</sub>	Measured value AIN02 Byte3 <sub>2</sub>
12	00	reserved	w <sub>3</sub> w <sub>3</sub>	Measured value AIN04 Byte0 <sub>3</sub>
13	00	reserved	w <sub>3</sub> w <sub>3</sub>	Measured value AIN04 Byte1 <sub>3</sub>
14	04	Channel byte AIN04	w <sub>3</sub> w <sub>3</sub>	Measured value AIN04 Byte2 <sub>3</sub>
15	01	Range byte +/- 10.2V	w <sub>3</sub> w <sub>3</sub>	Measured value AIN04 Byte3 <sub>3</sub>

Measured value AIN01

$$= (\text{integer}) (\text{Byte3}_1 * 0x1000000 + \text{Byte2}_1 * 0x10000 + \text{Byte1}_1 * 0x100 + \text{Byte0}_1) [\mu\text{V}]$$

Measured value AIN02

$$= (\text{integer}) (\text{Byte3}_2 * 0x1000000 + \text{Byte2}_2 * 0x10000 + \text{Byte1}_2 * 0x100 + \text{Byte0}_2) [\mu\text{V}]$$

Measured value AIN04

$$= (\text{integer}) (\text{Byte3}_3 * 0x1000000 + \text{Byte2}_3 * 0x10000 + \text{Byte1}_3 * 0x100 + \text{Byte0}_3) [\mu\text{V}]$$

## Reset ADC FIFO

The following command performs a reset of the ADC FIFO.  
This should be done after an overflow.

Byte	Transmit	Representing	Receive	Representing
0	0A	Command code 1st Byte	0A	Command code 1st Byte
1	00	Command code 2nd Byte	00	Command code 2nd Byte
2	06	Command code 3rd Byte	06	Command code 3rd Byte
3	00	Length byte	00	Length byte → 0 Bytes

## Read ADC FIFO overflow flag

The following command reads the overflow flag of the ADC-FIFO. Along with the read, the overflow flag is reset.

Byte	Transmit	Representing	Receive	Representing
0	0A	Command code 1st Byte	0A	Command code 1st Byte
1	00	Command code 2nd Byte	00	Command code 2nd Byte
2	07	Command code 3rd Byte	07	Command code 3rd Byte
3	00	Length byte	01	Length byte → 4 Bytes
4			0w	Overflow flag 00 FIFO no overflow 01 FIFO overflow
5			00	reserved
6			00	reserved
7			00	reserved

### Read out ADC FIFO

Some commands do not return the measurement results directly along with the response command, but store the measured values in a FIFO. As a command example, multiple measurement or continuous measurement can be mentioned. The FIFO can be read out with the ADC FIFO readout command. The values hold in the FIFO are appended directly to the response of the command (up to 255 readings). If the FIFO does not contain any data, only a 4-byte response is returned to the computer.

#### Command structure

4 bytes are to be transmitted,  $4 + n \cdot 4$  bytes are to be received depending upon the amount of data  $n$  in the FIFO.

$n = 1 \dots 8$

Byte	Transmit	Representing	Receive	Representing
0	0A	Command code 1st Byte	0A	Command code 1st Byte
1	00	Command code 2nd Byte	00	Command code 2nd Byte
2	08	Command code 3rd Byte	08	Command code 3rd Byte
3	00	Length byte	nn	Length byte → $n \cdot 4$ Bytes
4			ww <sub>1</sub>	Measured value <sub>1</sub> Byte0 <sub>1</sub>
5			ww <sub>1</sub>	Measured value <sub>1</sub> Byte1 <sub>1</sub>
6			ww <sub>1</sub>	Measured value <sub>1</sub> Byte2 <sub>1</sub>
7			ww <sub>1</sub>	Measured value <sub>1</sub> Byte3 <sub>1</sub>
			:	
			:	
$n \cdot 4$			ww <sub>n</sub>	Measured value <sub>n</sub> Byte0 <sub>n</sub>
$n \cdot 4 + 1$			ww <sub>n</sub>	Measured value <sub>n</sub> Byte1 <sub>n</sub>
$n \cdot 4 + 2$			ww <sub>n</sub>	Measured value <sub>n</sub> Byte2 <sub>n</sub>
$n \cdot 4 + 3$			ww <sub>n</sub>	Measured value <sub>n</sub> Byte3 <sub>n</sub>

Example 1:  
FIFO is empty:

Byte	Transmit	Representing	Receive	Representing
0	0A	Command code 1st Byte	0A	Command code 1st Byte
1	00	Command code 2nd Byte	00	Command code 2nd Byte
2	08	Command code 3rd Byte	08	Command code 3rd Byte
3	00	Length byte	00	Length byte

Example 2:  
The FIFO holds two measured values

Byte	Transmit	Representing	Receive	Representing
0	0A	Command code 1st Byte	0A	Command code 1st Byte
1	00	Command code 2nd Byte	00	Command code 2nd Byte
2	08	Command code 3rd Byte	08	Command code 3rd Byte
3	00	Length byte	2	Length byte → 8 bytes
4			ww <sub>1</sub>	Measured value <sub>1</sub> Byte0 <sub>1</sub>
5			ww <sub>1</sub>	Measured value <sub>1</sub> Byte1 <sub>1</sub>
6			ww <sub>1</sub>	Measured value <sub>1</sub> Byte2 <sub>1</sub>
7			ww <sub>1</sub>	Measured value <sub>1</sub> Byte3 <sub>1</sub>
8			ww <sub>2</sub>	Measured value <sub>2</sub> Byte0 <sub>2</sub>
9			ww <sub>2</sub>	Measured value <sub>2</sub> Byte1 <sub>2</sub>
10			ww <sub>2</sub>	Measured value <sub>2</sub> Byte2 <sub>2</sub>
11			ww <sub>2</sub>	Measured value <sub>2</sub> Byte3 <sub>2</sub>



## Programming:

- Transmitting: to read data from the FIFO the 4 byte holding command has to be sent to the module
- Receiving the data: since the array length of the data to be received may vary, the receiving of the entire data block has to be partitioned.

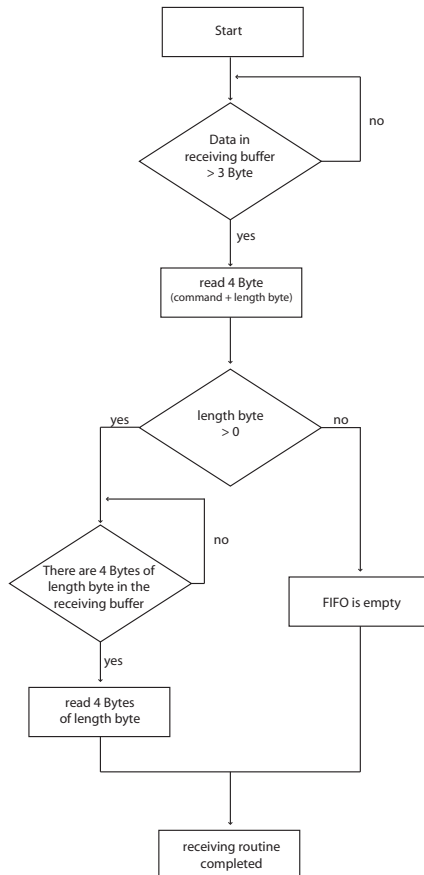

## AD Multiple Measurement

The A/D multiple measurement allows the user to sample one or more channels several times (up to 65,535 times) in an adjustable clock (1 - 100000kHz). The measured values are stored by the module in the internal FIFO and can be retrieved there during and after the sampling process. The values are buffered in the FIFO until they either have been fetched or a new sampling command has been called.

Attention: it must be ensured that the FIFO can be emptied fast enough, since the FIFO is limited to 10,000 readings. Furthermore, no EXDUL information register (e.g. UserA, UserB) may be written during the processing.

### Channel:

Channel	Channel byte
Single Ended	
AIN00	0
AIN01	1
AIN02	2
AIN03	3
AIN04	4
AIN05	5
AIN06	6
AIN07	7
Differential measuring	
AIN00+ / AIN01-	8
AIN00- / AIN01+	9
AIN02+ / AIN03-	10
AIN02- / AIN03+	11
AIN04+ / AIN05-	12
AIN04- / AIN05+	13
AIN06+ / AIN07-	14
AIN06- / AIN07+	15

### Measuring range:

Range byte	Voltage
0	+/- 20.4V (Differential measuring only max +/- 10.2V → GND)
1	+/-10.2V
2	+/- 5.1V
3	+/-2,55V
4	+/-1.27V
5	+/- 0.63V

## Command structure

n = 1 .... 8

Byte	Transmit	Representing	Receive	Representing
0	0A	Command code 1st Byte	0A	Command code 1st Byte
1	00	Command code 2nd Byte	00	Command code 2nd Byte
2	09	Command code 3rd Byte	09	Command code 3rd Byte
3	n + 2	Length byte	00	Length byte
4	ff	Sampling rate Byte0		
5	ff	Sampling rate Byte1		
6	ff	Sampling rate Byte2		
7	00	reserved		
8	aa	Number of readings Byte0		
9	aa	Number of readings Byte1		
10	00	reserved		
11	00	reserved		
12	00	reserved		
13	00	reserved		
14	cc <sub>n</sub>	Channel byte <sub>1</sub>		
15	bb <sub>n</sub>	Range byte <sub>1</sub>		
	:			
	:			
n*4 + 8	00	reserved		
n*4 + 9	00	reserved		
n*4 + 10	cc <sub>n</sub>	Channel byte <sub>1</sub>		
n*4 + 11	bb <sub>n</sub>	Range byte <sub>1</sub>		

Sampling rate = Byte2 \* 65536 + Byte1 \* 256 + Byte0

Number of readings = Byte1 \* 256 + Byte0

### Start AD continuous sampling

The A/D continuous measurement allows the user to sample one or more channels at regular intervals (1s - 10 $\mu$ s). The measured values are stored by the module into the internal FIFO and can be retrieved there during and after the sampling process. The values are buffered in the FIFO until they either have been fetched or a new sampling command has been called. To stop the continuous measurement the command „stop continuous A/D sampling“ must be sent to the module.

Attention: it must be ensured that the FIFO can be emptied quickly enough since the FIFO is limited to 10,000 readings. Furthermore, no EXDUL information register (e.g. UserA, UserB) may be written during the processing.

#### Channel:

Channel	Channel byte
Single Ended	
AIN00	0
AIN01	1
AIN02	2
AIN03	3
AIN04	4
AIN05	5
AIN06	6
AIN07	7
Differential measuring	
AIN00+ / AIN01-	8
AIN00- / AIN01+	9
AIN02+ / AIN03-	10
AIN02- / AIN03+	11
AIN04+ / AIN05-	12
AIN04- / AIN05+	13
AIN06+ / AIN07-	14
AIN06- / AIN07+	15

#### Measuring range:

Range byte	Voltage
0	+/- 20.4V (Differential measuring only max +/- 10.2V → GND)
1	+/-10.2V
2	+/- 5.1V
3	+/-2,55V
4	+/-1.27V
5	+/- 0.63V

## Command structure

n = 1 .... 8

Byte	Transmit	Representing	Receive	Representing
0	0A	Command code 1st Byte	0A	Command code 1st Byte
1	00	Command code 2nd Byte	00	Command code 2nd Byte
2	0A	Command code 3rd Byte	0A	Command code 3rd Byte
3	n + 1	Length byte	00	Length byte
4	ff	Sampling rate Byte0		
5	ff	Sampling rate Byte1		
6	ff	Sampling rate Byte2		
7	00	reserved		
8	aa	reserved		
9	aa	reserved		
10	cc <sub>1</sub>	Channel byte <sub>1</sub>		
11	bb <sub>1</sub>	Range byte <sub>1</sub>		
	:			
	:			
n*4 + 4	00	reserved		
n*4 + 5	00	reserved		
n*4 + 6	cc <sub>n</sub>	Channel byte <sub>1</sub>		
n*4 + 7	bb <sub>n</sub>	Range byte <sub>1</sub>		

Sampling rate = Byte2 \* 65536 + Byte1 \* 256 + Byte0

## Stop AD continuous sampling

This command stops the AD continuous measurement.

Byte	Transmit	Representing	Receive	Representing
0	0A	Command code 1st Byte	0A	Command code 1st Byte
1	00	Command code 2nd Byte	00	Command code 2nd Byte
2	0B	Command code 3rd Byte	0B	Command code 3rd Byte
3	00	Length byte	00	Length byte

### **11.5 Access to the Module via LabVIEW and EXDUL.dll**

Due to the EXDUL.dll., the module can be integrated into a LABView project without much effort. Along with the .NET.Framework additionally LABView and the EXDUL.dll file is required on the computer.

We refer to the EXDUL-LABView Tutorial for more detailed information.

## 12. FAQ - Trouble Shooting

Following you can find a brief compilation of the most common causes of failure that may appear during commissioning or when accessing to the EXDUL-581 or to the EXDUL web page. At first, please check following points before contacting your distributor:

### Is the supply voltage of the EXDUL-581 connected properly?

A voltage supply of +10 V ... +24 V DC across terminal 23 (Vcc) and terminal 24 (GND) is required for operation. Please check the screw terminal connections on the module as well as the power supply unit and the connections to the power supply.

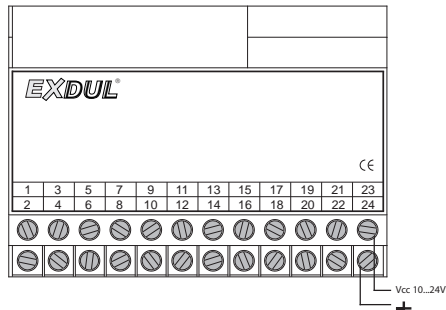

### Is the connection LED on the RJ45 jack lit green continuously?

After operating voltage is applied, the EXDUL-581 will boot up. Once a stable Ethernet connection is established, the LED on 8P8C modular connector (RJ45 jack) is lit green continuously.

If this is not the case, please check the direct cable connection between EXDUL-581 and computer (a crossover cable might be required). For network operation, check network cables between EXDUL-581 and the wall-mounted network socket, the active Ethernet switch or the Ethernet hub.

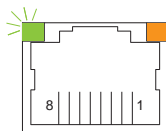

**Is there a stable Ethernet connection between PC and network?**

Check the network cable between EXDUL-581 and the network socket (RJ45 wall outlet), the active Ethernet switch or Ethernet hub. The Ethernet cable has to be suitable for the Ethernet connection, undamaged and properly plugged at both ends. Current computers mostly provide two LED's on the network socket of the network adapter. If connection to the network is established, the green LED is lit continuously. If the network socket of the computer provides only one LED it flashes or flickers when network connection is operating.

**Is the network cable used suitable for the connection?**

When connecting EXDUL-581 to a switch, hub or PC with an auto MDI-X supporting Ethernet interface, a standard network cable (Cat 5 or above) can be used. Older computers whose Ethernet interface does not automatically cross the transmission and receiver lines, may require a crossover cable or crossover adapter.

**Is the wall-mounted network outlet active?**

If you connect the EXDUL-581 to a permanent installed network via a wall outlet, together with your network administrator check whether the wall socket is active and connected to an active Ethernet switch or Ethernet hub.

**Is the computer's Ethernet interface activated?**

The Ethernet adapter has to be activated in the BIOS of your PC. Check the Windows Device Manager whether it is listed under network adapter. The entry must not be marked with an exclamation mark!

**Are the computer's network settings correct?**

Each active device in a TCP-IP based network requires a unique IP address, which is structured into a network ID and a device ID. The Subnet mask separates the IP address in a network part (network prefix, network ID) and a device part (device ID).



By default, the EXDUL-581 is set to DHCP client. To access the EXDUL-581 the used PC has to be set to **„IP-Adresse automatisch beziehen (DHCP-aktiviert)“** and the network has to provide a DHCP server (integrated in most of the routers). The DHCP server automatically assigns a subnet mask and an IP address to the EXDUL-581 and to the computer. If the basic setting has been changed to static IP address, the used computer also has to be set to static address (**Folgende IP-Adresse verwenden**).

Example: The static IP address for the EXDUL-581 is 192.168.1.199 (network ID: 192.168.1., device ID 199). To access the EXDUL-581 the used PC has to be set to subnet mask 255.255.255.0 and to static IP address ranging from 192.168.1.1 up to 192.168.1.244

## How to check the network configuration of the PC

You can monitor the TCP/IP settings of your computer via the Internet Protocol Version 4 (TCP/IPv4) Properties window or the status of the LAN connection respectively (see „How to check and to change IP address of the PC“). Alternatively type the simple command **IPCONFIG** to the command-line. For this, switch to the MS-DOS prompt (see „How to switch to MS-DOS prompt“), type **ipconfig** and press enter to confirm. The response should look similar to the following figure:

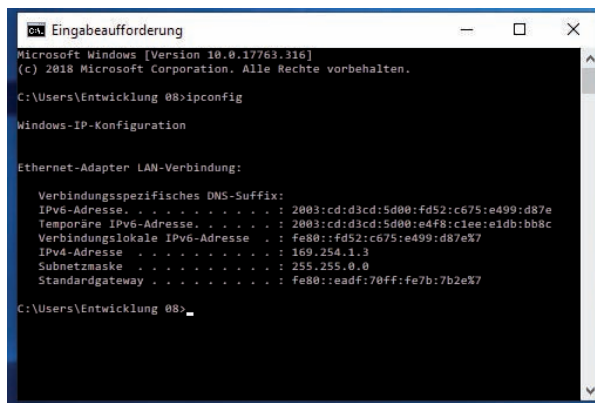

```
ov Eingabeaufforderung
Microsoft Windows [Version 10.0.17763.316]
(c) 2018 Microsoft Corporation. Alle Rechte vorbehalten.

C:\Users\Entwicklung 08>ipconfig

Windows-IP-Konfiguration

Ethernet-Adapter LAN-Verbindung:

    Verbindungsspezifisches DNS-Suffix:
    IPv6-Adresse . . . . . : 2803:cd:d3cd:5d00:fd52:c675:e499:d87e
    Temporäre IPv6-Adresse. . . . . : 2803:cd:d3cd:5d00:e4f8:c1ee:a1db:bb8c
    Verbindungslokale IPv6-Adresse . . : fe80::fd52:c675:e499:d87e%7
    IPv4-Adresse . . . . . : 169.254.1.3
    Subnetzmaske . . . . . : 255.255.0.0
    Standardgateway . . . . . : fe80::eadf:70ff:fe7b:7b2e%7

C:\Users\Entwicklung 08>
```

## How to check and to change IP address of the PC

Windows7:

Start -> Control Panel -> Network and Internet (view network status and tasks) -> Change adapter settings -> select relevant LAN connection in the window Local Area Connections (double-click or right mouse button) -> properties -> highlight Internet Protocol Version 4 (TCP/IPV4) -> properties  
Please note: you have to own administrator privileges for changing TCP/IP settings!

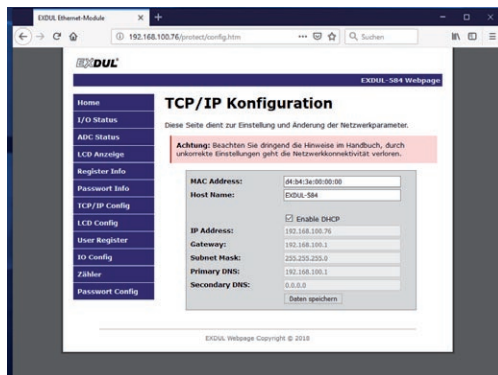

WindowsXP:

Start -> ControlPanel -> Network & Connections -> Local Area Connection -> right mouse button to Properties -> highlight Internet Protocol (TCP/IP) -> Properties  
Please note: you have to own administrator privileges for changing TCP/IP settings!

## How to switch to MS-DOS prompt

Windows7:

Start -> type **cmd** to the input box (search programs and files) -> press enter to confirm

or

Start -> All Programs -> Accessories -> command prompt

WindowsXP:

Start -> Run -> type **cmd** to the run box-> OK

or

Start -> All Programs -> Accessories -> command prompt

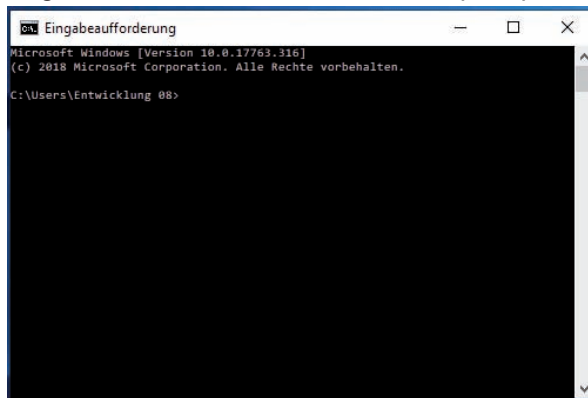

## Is it possible to locate modules EXDUL-5xx in an existing network and to detect the network data?

All EXDUL-5xx modules send detection signals at certain intervals. The program **ExdulUtility\_v2\_xx** (or above) evaluates the identification data and compiles a list with host name, IP address and MAC address. It is suitable for any single EXDUL-5xx directly connected to a PC as well as for a network connected via hub or switch with several modules. In case the firewall prevents the searching program from communicating with the EXDUL-5xx a release is required.

## 13. Specifications

### **A/D Inputs**

8 inputs single-ended (se) or 4 inputs differential (diff)

or combined se/diff software-sectable

Resolution: 16 Bit

Input voltage range bipolar:

+/-0,63 Volt, +/-1,27 Volt, +/-2,55 Volt, +/-5.1 Volt, +/-10.2 Volt

+/-20.4V (differential inputs only)

FIFO: 10,000 readings

Input resistance: > 500 M $\Omega$

Over voltage protection: +/- 50V

Sampling rate: max 100 kS

### **Optocoupler inputs**

8 channels bipolar

Over voltage protection diodes

Input voltage range

high = 10..30 Volt

low = 0..3 Volt

Input frequency: max. 10 kHz

### **Optocoupler Outputs**

2 channels

High capacity optocouplers

Reverse polarity protection

Output current max. 150mA

Voltage collector-emitter: max. 50V

### **Counters**

5 programmable counters 32 bit (using 5 optocoupler inputs)

Counting frequency: max. 5 kHz

### **LCD Display (EXDUL-581E only)**

Matrix display with 2 lines and 16 columns displaying 16 characters each line

Programmable to display application-specific data or representing I/O status

**Connection Terminals**

1 \* 24pin screw terminal block  
Ethernet RJ45 socket

**Ethernet connection line**

RJ45 network cable Cat5 or above

**Dimensions**

105 mm x 89 mm x 59 mm (l x b x h)

**Casing**

Insulating plastic housing with integrated snap-in technology for DIN EN top hat rail mounting.

Suitable for control and engineering technology mounted to control and distribution boxes, surface mounting or mobile use on a desk.

# 14. Circuitry Examples

## 14.1 Wiring of the Optocoupler Inputs

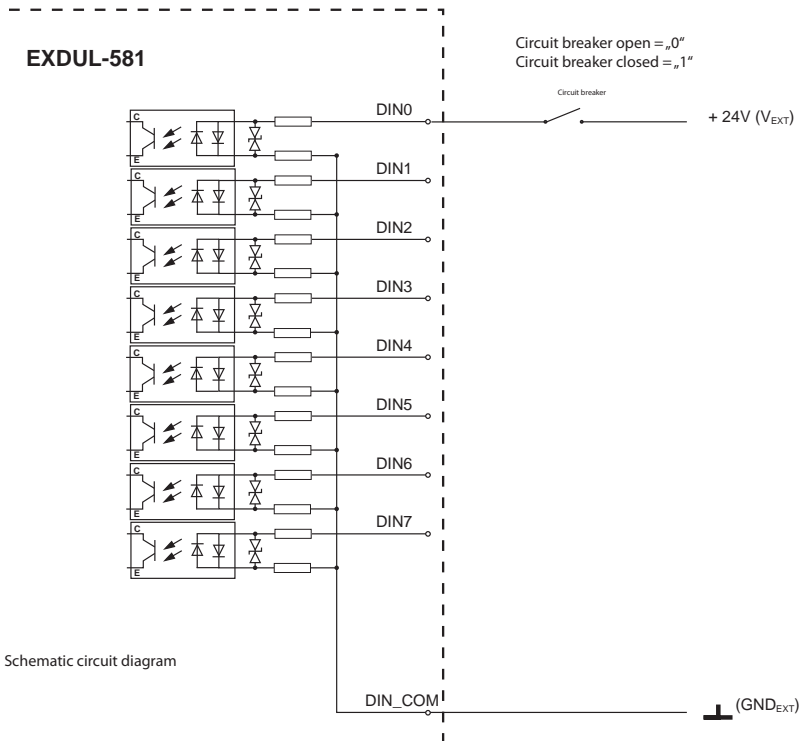

Figure 14.1.1 Wiring of the Optocoupler Inputs

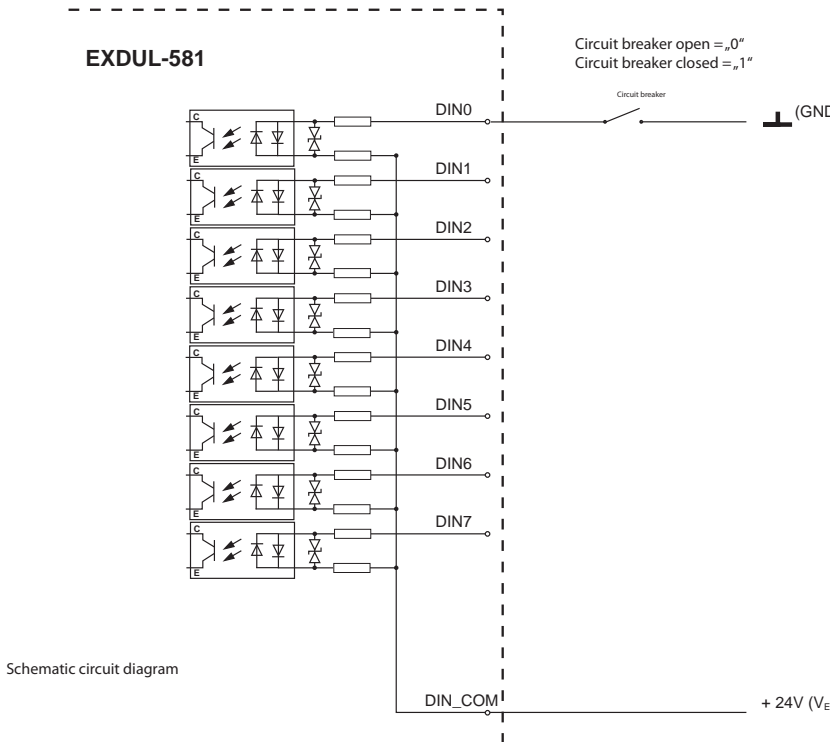

Fig 14.1.2 Wiring of the optocoupler inputs revers

## 14.2 Wiring of the Optocoupler Outputs

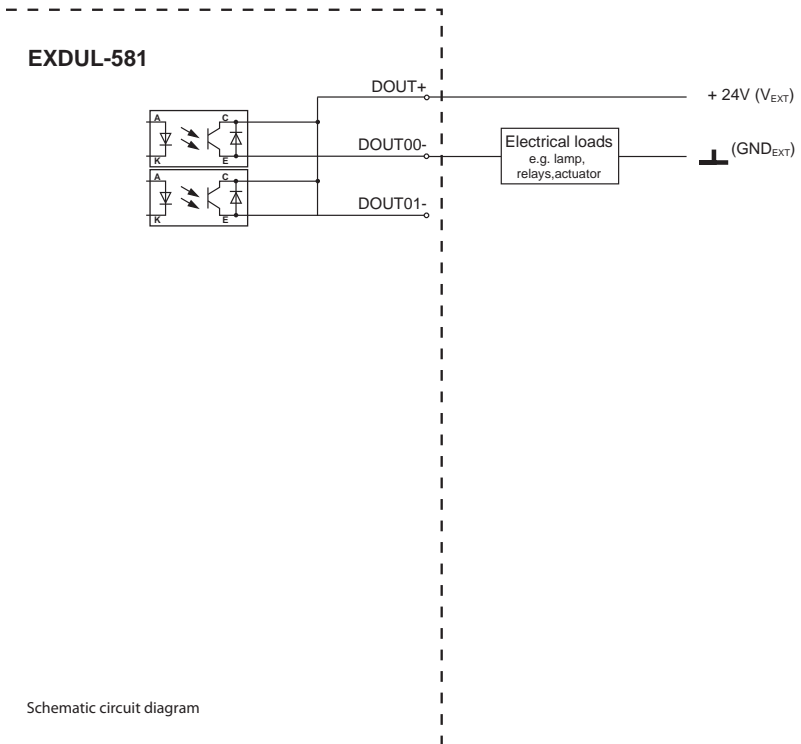

Figure 14.2 Optocoupler output wiring



### 14.3 Wiring of the A/D Inputs single ended

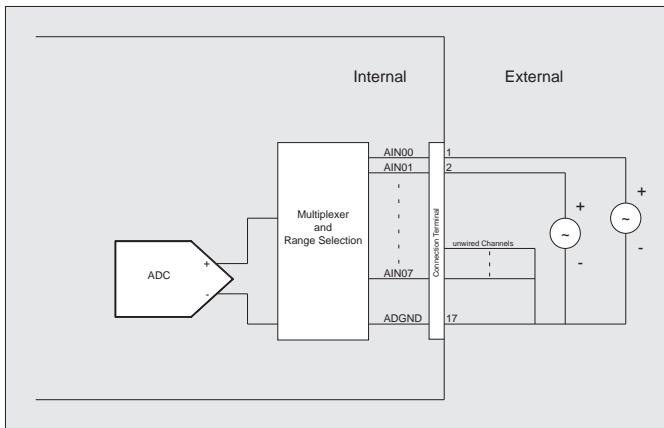

Figure 14.3 Wiring of the A/D inputs (single ended)

## 14.4 Wiring of the A/D Inputs differential

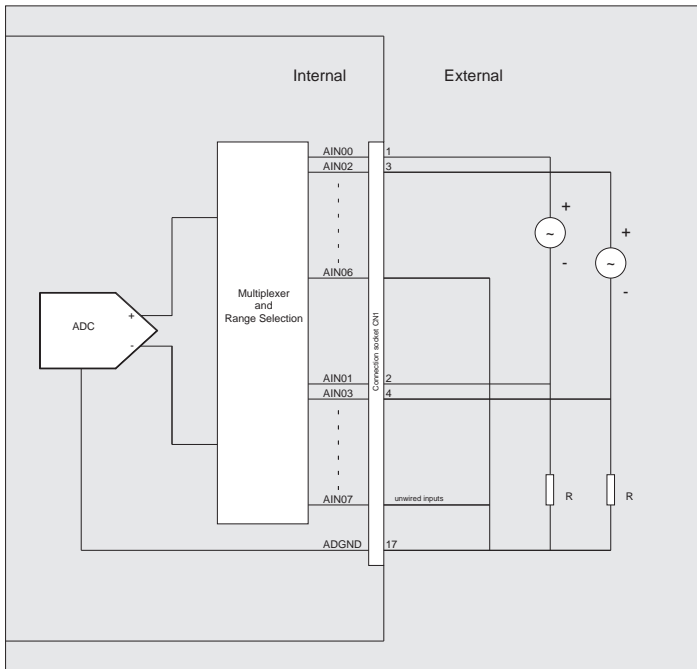

Figure 14.4 Wiring of the A/D inputs (differential)

## 15. ASCII Table

Hex	Dec	Binary	Character	Hex	Dec	Binary	Character
00	0	00000000		28	40	00101000	(
01	1	00000001		29	41	00101001	)
02	2	00000010		2A	42	00101010	*
03	3	00000011		2B	43	00101011	+
04	4	00000100		2C	44	00101100	,
05	5	00000101		2D	45	00101101	-
06	6	00000110		2E	46	00101110	.
07	7	00000111		2F	47	00101111	/
08	8	00001000		30	48	00110000	0
09	9	00001001		31	49	00110001	1
0A	10	00001010		32	50	00110010	2
0B	11	00001011		33	51	00110011	3
0C	12	00001100		34	52	00110100	4
0D	13	00001101		35	53	00110101	5
0E	14	00001110		36	54	00110110	6
0F	15	00001111		37	55	00110111	7
10	16	00010000		38	56	00111000	8
11	17	00010001		39	57	00111001	9
12	18	00010010		3A	58	00111010	:
13	19	00010011		3B	59	00111011	;
14	20	00010100		3C	60	00111100	<
15	21	00010101		3D	61	00111101	=
16	22	00010110		3E	62	00111110	>
17	23	00010111		3F	63	00111111	?
18	24	00011000		40	64	01000000	@
19	25	00011001		41	65	01000001	A
1A	26	00011010		42	66	01000010	B
1B	27	00011011		43	67	01000011	C
1C	28	00011100		44	68	01000100	D
1D	29	00011101		45	69	01000101	E
1E	30	00011110		46	70	01000110	F
1F	31	00011111		47	71	01000111	G
20	32	00100000	[space]	48	72	01001000	H
21	33	00100001	!	49	73	01001001	I
22	34	00100010	"	4A	74	01001010	J
23	35	00100011	#	4B	75	01001011	K
24	36	00100100	\$	4C	76	01001100	L
25	37	00100101	%	4D	77	01001101	M
26	38	00100110	&	4E	78	01001110	N
27	39	00100111	'	4F	79	01001111	O

Hex	Dec	Binary	Character
50	80	01010000	P
51	81	01010001	Q
52	82	01010010	R
53	83	01010011	S
54	84	01010100	T
55	85	01010101	U
56	86	01010110	V
57	87	01010111	W
58	88	01011000	X
59	89	01011001	Y
5A	90	01011010	Z
5B	91	01011011	[
5C	92	01011100	
5D	93	01011101	]
5E	94	01011110	^
5F	95	01011111	_
60	96	01100000	`
61	97	01100001	a
62	98	01100010	b
63	99	01100011	c
64	100	01100100	d
65	101	01100101	e
66	102	01100110	f
67	103	01100111	g
68	104	01101000	h
69	105	01101001	i
6A	106	01101010	j
6B	107	01101011	k
6C	108	01101100	l
6D	109	01101101	m
6E	110	01101110	n
6F	111	01101111	o
70	112	01110000	p
71	113	01110001	q
72	114	01110010	r
73	115	01110011	s
74	116	01110100	t
75	117	01110101	u
76	118	01110110	v
77	119	01110111	w
78	120	01111000	x
79	121	01111001	y
7A	122	01111010	z
7B	123	01111011	{

Hex	Dec	Binary	Character
7C	124	01111100	
7D	125	01111101	}
7E	126	01111110	
7F	127	01111111	
80	128	10000000	
81	129	10000001	
82	130	10000010	
83	131	10000011	
84	132	10000100	
85	133	10000101	
86	134	10000110	
87	135	10000111	
88	136	10001000	
89	137	10001001	
8A	138	10001010	
8B	139	10001011	
8C	140	10001100	
8D	141	10001101	
8E	142	10001110	
8F	143	10001111	
90	144	10010000	
91	145	10010001	
92	146	10010010	
93	147	10010011	
94	148	10010100	
95	149	10010101	
96	150	10010110	
97	151	10010111	
98	152	10011000	
99	153	10011001	
9A	154	10011010	
9B	155	10011011	
9C	156	10011100	
9D	157	10011101	
9E	158	10011110	
9F	159	10011111	
A0	160	10100000	
A1	161	10100001	
A2	162	10100010	
A3	163	10100011	
A4	164	10100100	
A5	165	10100101	
A6	166	10100110	
A7	167	10100111	

Hex	Dec	Binary	Character
A8	168	10101000	
A9	169	10101001	
AA	170	10101010	
AB	171	10101011	
AC	172	10101100	
AD	173	10101101	
AE	174	10101110	
AF	175	10101111	
B0	176	10110000	
B1	177	10110001	
B2	178	10110010	
B3	179	10110011	
B4	180	10110100	
B5	181	10110101	
B6	182	10110110	
B7	183	10110111	
B8	184	10111000	
B9	185	10111001	
BA	186	10111010	
BB	187	10111011	
BC	188	10111100	
BD	189	10111101	
BE	190	10111110	
BF	191	10111111	
C0	192	11000000	
C1	193	11000001	
C2	194	11000010	
C3	195	11000011	
C4	196	11000100	
C5	197	11000101	
C6	198	11000110	
C7	199	11000111	
C8	200	11001000	
C9	201	11001001	
CA	202	11001010	
CB	203	11001011	
CC	204	11001100	
CD	205	11001101	
CE	206	11001110	
CF	207	11001111	
D0	208	11010000	
D1	209	11010001	
D2	210	11010010	
D3	211	11010011	

Hex	Dec	Binary	Character
D4	212	11010100	
D5	213	11010101	
D6	214	11010110	
D7	215	11010111	
D8	216	11011000	
D9	217	11011001	
DA	218	11011010	
DB	219	11011011	
DC	220	11011100	
DD	221	11011101	
DE	222	11011110	
DF	223	11011111	
E0	224	11100000	
E1	225	11100001	
E2	226	11100010	
E3	227	11100011	
E4	228	11100100	
E5	229	11100101	
E6	230	11100110	
E7	231	11100111	
E8	232	11101000	
E9	233	11101001	
EA	234	11101010	
EB	235	11101011	
EC	236	11101100	
ED	237	11101101	
EE	238	11101110	
EF	239	11101111	
F0	240	11110000	
F1	241	11110001	
F2	242	11110010	
F3	243	11110011	
F4	244	11110100	
F5	245	11110101	
F6	246	11110110	
F7	247	11110111	
F8	248	11111000	
F9	249	11111001	
FA	250	11111010	
FB	251	11111011	
FC	252	11111100	
FD	253	11111101	
FE	254	11111110	
FF	255	11111111	

## 16. Product Liability Act

### Information for Product Liability

The Product Liability Act (Act on Liability for Defective Products - ProdHaftG) in Germany regulates the manufacturer's liability for damages caused by defective products.

The obligation to pay compensation can already be given, if the product's presentation could cause a misconception of safety to a non-commercial end-user and also if the end-user is expected not to observe the necessary safety instructions when handling this product.

It must therefore always be provable, that the end-user has been made familiar with the safety rules.

In the interest of safety, please always point out the following safety instructions to your non-commercial customers:

### Safety instructions

The applicable VDE-instructions must be observed, when handling products that come into contact with electrical voltage.

Particular attention must be drawn to the following instructions:  
VDE100; VDE0550/0551; VDE0700; VDE0711; VDE0860.

You can obtain the instructions from:

vde-Verlag GmbH  
Bismarckstr. 33  
10625 Berlin

\* pull the mains plug before you open the unit or make sure, there is no current to/in the unit.

\* You only may put into operation any components, boards or devices, if they have been installed inside a secure touch-protected casing before. During installation there must be no current to the equipment.

\* Make sure that the device is disconnected from the power supply before using any tools on any components, boards or devices. Any electric charges saved in components in the device are to be discharged prior.

\* Live cables or wires, which are connected to the unit, the components or the boards, must be inspected for insulation faults or breakages. In case of any defect in a line the device must be taken out of operation immediately until the defective line has been replaced.

\* When using components or boards you must strictly adhere to the characteristic data for electrical parameters specified in the corresponding description.

\* As a non-commercial end-user, if it is not clear whether the electrical parameters given in the description provided are applicable for a component, you must consult an expert.

Furthermore, the compliance with building and safety instructions of all kinds (VDE, TÜV, industrial injuries corporation, etc.) is subject to the user/customer.

## 17. CE Declaration of Conformity

This is to certify, that the products

**EXDUL-581E EDP Number A-371772**  
**EXDUL-581S EDP Number A-371760**

comply with the requirements of the relevant EC directives. This declaration will lose its validity, if the instructions given in this manual for the intended use of the products are not fully complied with.

EN 5502 Class B  
IEC 801-2  
IEC 801-3  
IEC 801-4  
EN 50082-1  
EN 60555-2  
EN 60555-3

The following manufacturer is responsible for this declaration:

Messcomp Datentechnik GmbH  
Neudecker Str. 11  
83512 Wasserburg

issued by

Dipl.Ing.(FH) Hans Schnellhammer

Wasserburg, 31.01.2019



---



## Referenzsystem-Bestimmungsgemäßer Betrieb

Die Multifunktionsmodule EXDUL-581E und EXDUL-581S sind nicht selbständig betreibbare Geräte, dessen CE-Konformität nur bei gleichzeitiger Verwendung von zusätzlichen Computerkomponenten beurteilt werden kann. Die Angaben zur CE-Konformität beziehen sich deshalb ausschließlich auf den bestimmungsgemäßen Einsatz der Multifunktionsmodule in folgendem Referenzsystem:

Schaltschrank:	Vero IMRAK 3400	804-530061C 802-563424J 802-561589J
19" Gehäuse:	Vero PC-Gehäuse	145-010108L
19" Gehäuse:	Zusatzelektronik	519-112111C
Motherboard:	GA-586HX	PIV 1.55
Floppy-Controller:	auf Motherboard	
Floppy:	TEAC	FD-235HF
Grafikkarte:	Advantech	PCA-6443
Schnittstellen:	EXDUL-581E EXDUL-581S	A-371772 A-371760